

# Toledo Scale Interface Module

M/N 57C428

---

Instruction Manual J-3644-2

---

**RELIANCE  
ELECTRIC** 

The information in this user's manual is subject to change without notice.

**WARNING**

**THIS UNIT AND ITS ASSOCIATED EQUIPMENT MUST BE INSTALLED, ADJUSTED AND MAINTAINED BY QUALIFIED PERSONNEL WHO ARE FAMILIAR WITH THE CONSTRUCTION AND OPERATION OF ALL EQUIPMENT IN THE SYSTEM AND THE POTENTIAL HAZARDS INVOLVED. FAILURE TO OBSERVE THESE PRECAUTIONS COULD RESULT IN BODILY INJURY.**

**WARNING**

**INSERTING OR REMOVING THIS MODULE OR ITS CONNECTING CABLES MAY RESULT IN UNEXPECTED MACHINE MOTION. POWER TO THE MACHINE SHOULD BE TURNED OFF BEFORE INSERTING OR REMOVING THE MODULE OR ITS CONNECTING CABLES. FAILURE TO OBSERVE THESE PRECAUTIONS COULD RESULT IN BODILY INJURY.**

**CAUTION**

**THIS MODULE CONTAINS STATIC-SENSITIVE COMPONENTS. CARELESS HANDLING CAN CAUSE SEVERE DAMAGE.**

**DO NOT TOUCH THE CONNECTORS ON THE BACK OF THE MODULE. WHEN NOT IN USE, THE MODULE SHOULD BE STORED IN AN ANTI-STATIC BAG. THE PLASTIC COVER SHOULD NOT BE REMOVED. FAILURE TO OBSERVE THIS PRECAUTION COULD RESULT IN DAMAGE TO OR DESTRUCTION OF THE EQUIPMENT.**

Toledo Scale™ is a trademark of Toledo Scale, Inc.

Reliance® is a registered trademark of Reliance Electric Company or its subsidiaries.

# Table of Contents

<b>1.0</b>	<b>Introduction</b>	<b>1-1</b>
<b>2.0</b>	<b>Mechanical/Electrical Description</b>	<b>2-1</b>
2.1	Mechanical Description	2-1
2.2	Electrical Description	2-1
<b>3.0</b>	<b>Installation</b>	<b>3-1</b>
3.1	Wiring	3-1
3.2	Initial Installation	3-1
3.3	Module Replacement	3-3
<b>4.0</b>	<b>Programming</b>	<b>4-1</b>
4.1	Register Organization	4-1
4.1.1	Status and Control Registers	4-1
4.1.2	Toledo Scale Data Registers	4-3
4.2	Configuration	4-7
4.3	Reading Data in Application Tasks	4-7
4.3.1	Configuring the Module	4-8
4.3.2	Reading the Data	4-8
4.4	Message Transmission Time	4-9
4.5	Restrictions	4-9
4.5.1	Remote Racks	4-9
4.5.2	Reading Toledo Scale Data	4-9
4.5.3	Writing Data to Registers	4-9
<b>5.0</b>	<b>Diagnostics and Troubleshooting</b>	<b>5-1</b>
5.1	No Activity on Serial Line	5-1
5.2	Incorrect Data	5-2
5.3	Bus Error	5-3

# Appendices

<b>Appendix A</b>	
Technical Specifications . . . . .	A-1
<b>Appendix B</b>	
Module Block Diagram . . . . .	B-1
<b>Appendix C</b>	
Field Connections . . . . .	C-1
<b>Appendix D</b>	
Toledo Scale Continuous Output Message Format . . . . .	D-1
<b>Appendix E</b>	
Defining Variables in the Configuration Task . . . . .	E-1

# List of Figures

Figure 2.1 - Module Faceplate .....	2-2
Figure 2.2 - LED Fault Codes .....	2-3
Figure 3.1 - Typical Field Signal Connections .....	3-1
Figure 3.2 - Toledo Scale Digital Indicator Xmit Connector .....	3-2
Figure 3.3 - Rack Slot Numbers .....	3-2
Figure 4.1 - Dual Port Memory Organization .....	4-1
Figure 4.2 - Status and Control Registers .....	4-1
Figure 4.3 - Receive Message Status .....	4-2
Figure 4.4 - Configuration/Update Request Register .....	4-2
Figure 4.5 - Control Registers .....	4-3
Figure 4.6 - Request/Status Register Error Codes .....	4-4
Figure 4.7 - Message Counter Register .....	4-4
Figure 4.8 - Status Byte "A" .....	4-5
Figure 4.9 - Status Byte "B" .....	4-5
Figure 4.10 - Status Byte "C" .....	4-6
Figure 4.11 - Weight and Tare Registers .....	4-6
Figure 4.12 - Setpoint Flag Register .....	4-6
Figure 5.1 - Pulse Time for Different Baud Rates .....	5-1



# 1.0 INTRODUCTION

The products described in this instruction manual are manufactured or distributed by Reliance Electric Company or its subsidiaries.

The Toledo Scale Interface Module provides a single RS-232C serial I/O port for receiving data from Toledo Scale digital indicators (model numbers 8132, 8140, 8142, and 8530) that communicate via RS-232C with the Toledo Scale Continuous Output protocol. The serial data is stored in dual port memory where it can be read by application software.

This manual describes the functions and specifications of the module. It also includes a detailed overview of installation and servicing procedures, as well as examples of programming methods.

Related publications that may be of interest:

- J-3630 AutoMax PROGRAMMING EXECUTIVE INSTRUCTION MANUAL VERSION 1.0
- J-3649 AutoMax CONFIGURATION TASK MANUAL
- J-3650 AutoMax PROCESSOR MODULE INSTRUCTION MANUAL
- J-3675 AutoMax ENHANCED BASIC LANGUAGE INSTRUCTION MANUAL
- J-3676 AutoMax CONTROL BLOCK LANGUAGE INSTRUCTION MANUAL
- J-3677 AutoMax LADDER LOGIC LANGUAGE INSTRUCTION MANUAL
- J-3684 AutoMax PROGRAMMING EXECUTIVE INSTRUCTION MANUAL VERSION 2.0
- J-3750 ReSource AutoMax PROGRAMMING EXECUTIVE INSTRUCTION MANUAL VERSION 3.0
- IEEE 518 GUIDE FOR THE INSTALLATION OF ELECTRICAL EQUIPMENT TO MINIMIZE ELECTRICAL NOISE INPUTS TO CONTROLLERS FROM EXTERNAL SOURCES





## 2.0 MECHANICAL/ELECTRICAL DESCRIPTION

The following is a description of the faceplate LEDs, field termination connectors, and electrical characteristics of the field connections.

### 2.1 Mechanical Description

The Toledo Scale Interface module is a printed circuit board assembly that plugs into the backplane of the DCS5000/AutoMax rack. It consists of a printed circuit board, a faceplate, and a protective enclosure. The faceplate contains tabs at the top and bottom to simplify removing the module from the rack. Module dimensions are listed in Appendix A.

The faceplate of the module contains a 25 pin "D" shell connector for an RS-232C serial I/O link. For diagnostic purposes, the faceplate contains one seven-segment LED and a green status light that indicates when the board is operational (ON) or malfunctioning (OFF). There are also two thumbwheel switches on the faceplate of the module. These switches are not used in this application. See figure 2.1.

The back of the module contains two edge connectors that attach to the system backplane.

### 2.2 Electrical Description

The interface module contains a 4 mhz Z80 microprocessor. Processor memory consists of 16K bytes of EPROM memory for the communication software, 8K bytes of RAM for local data storage, and 4K words of dual port memory. The module is equipped with a RS-232C serial I/O port, a programmable baud rate generator, and the necessary circuitry to interface with the system backplane. Refer to the block diagram in Appendix B.

This module also contains a watchdog timer, used to detect hardware failures. The watchdog is enabled whenever power is turned on to the module. If a processor is unable to reset the watchdog, an interrupt will be generated to stop the processor. The dual port memory will be disabled so that it cannot be accessed by the user's application software.

There is one green status light and one 7-segment LED on the faceplate of the module. The status light is labeled "OK". When the light is on, the module has passed its power-up diagnostics and the watchdog timer has not timed out.

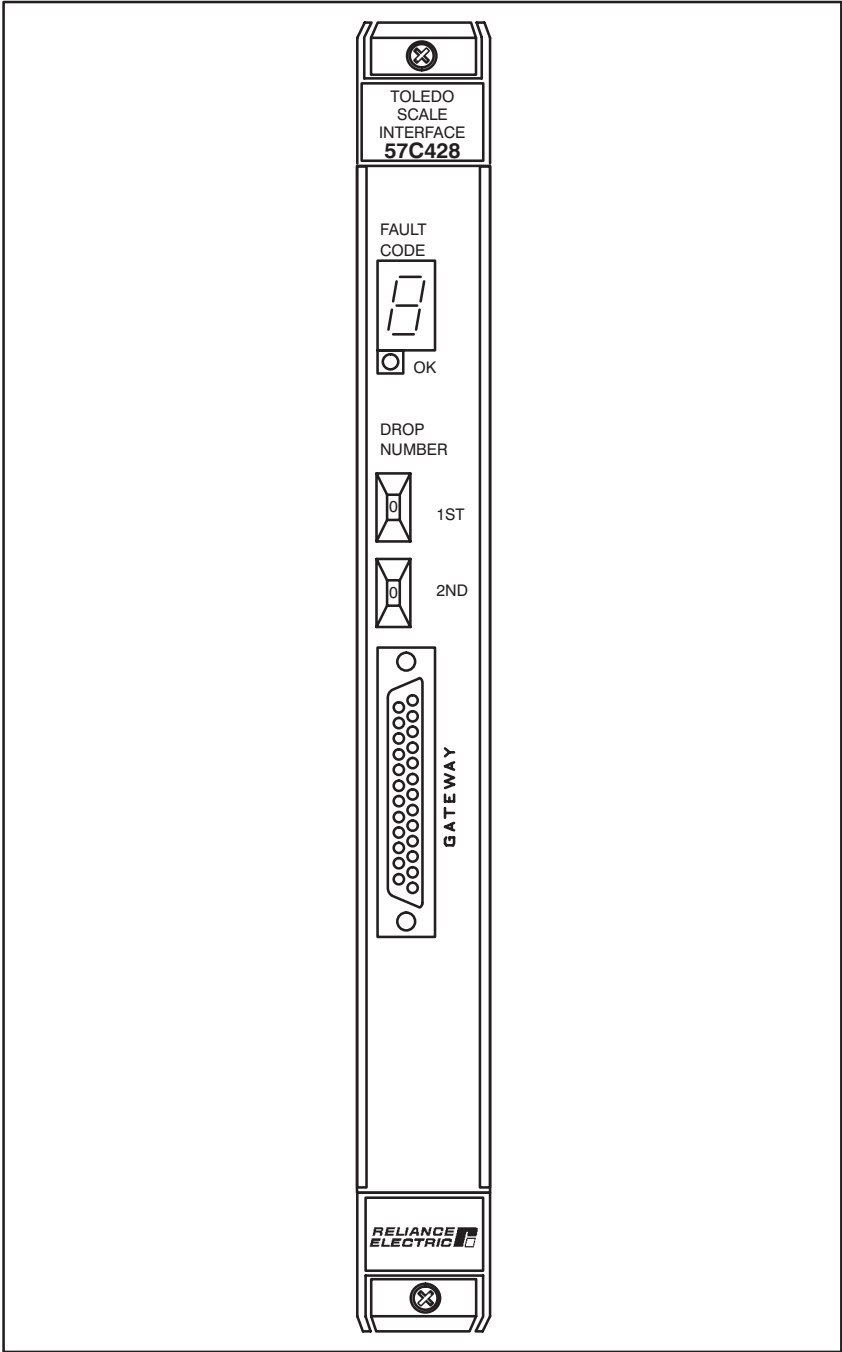

Figure 2.1- Module Faceplate

The 7-segment LED provides detailed information on the status of the module. If the LED displays any number from “0” through “9” inclusive or “b,” the module is malfunctioning and has not passed one of its power-up diagnostics. Three other possible displays indicate that the module has not been set up properly or that there is a fault somewhere else in the system. See figure 2.2 for an explanation of fault codes.

Fault Code	Explanation
0	CPU failed power-up diagnostic
1	EPROM failed power-up diagnostic
2	RAM failed power-up diagnostic
3	CTC failed power-up diagnostic
4	SIO failed power-up diagnostic
6	DPM failed power-up diagnostic
7	MMU failed power-up diagnostic
9	PIO failed power-up diagnostic
b	Watchdog failed power-up diagnostic
C	Communication line status. Displayed only if the link has not been configured by a DCS application task.
d	System (backplane) watchdog failed. Board is operational but will not receive data until the watchdog is reset.
E	Power failure. This code is normally displayed from the time that a power failure is detected until power is lost.

Figure 2.2- LED Fault Codes



## 3.0 INSTALLATION

This section describes how to install and remove the module and its cable assembly.

### 3.1 Wiring

The installation of wiring should conform to all applicable codes.

To reduce the possibility of electrical noise interfering with the proper operation of the control system, exercise care when installing the wiring from the system to the external devices. For detailed recommendations refer to IEEE 518.

### 3.2 Initial Installation

Use the following procedure to install the module:

- Step 1. Turn off power to the system. All power to the rack as well as all power to the wiring leading to the module should be off.
- Step 2. Fasten the two field wires to a 25 pin male D-shell connector. Typical field connections are shown in figure 3.1. Make certain that the other end of the cable is connected to the proper connector on the Toledo Scale digital indicator. Refer to figure 3.2 for the proper digital indicator connection.

Refer to Appendix C for the arrangement of terminal board connections. All field wires should be fastened securely.

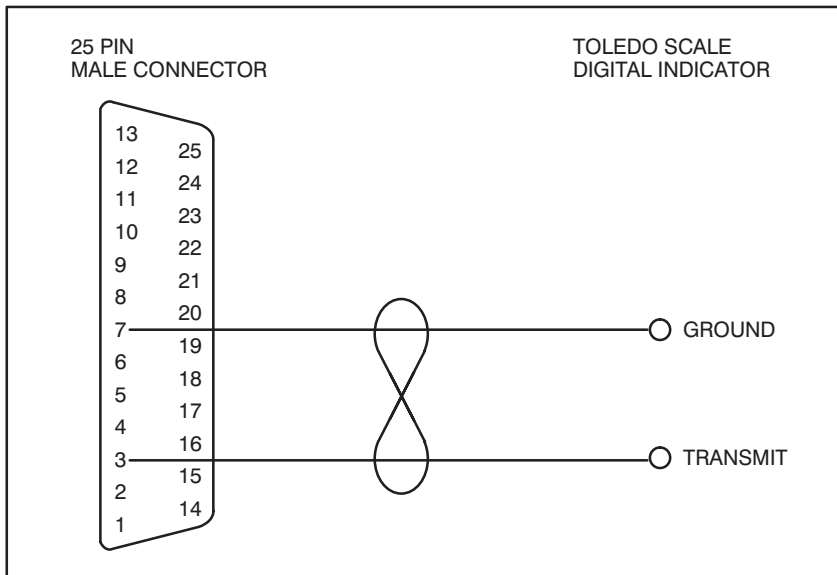

Figure 3.1 - Typical Field Signal Connections

Model	Connector
8132	J19
8140	J7 or J12
8142	JN
8530	JN

Figure 3.2- Toledo Scale Digital Indicator Xmit Connector

- Step 3. Take the module out of its shipping container. Take it out of the anti-static bag, being careful not to touch the connectors on the back of the module.
- Step 4. Insert the module into the desired slot in the rack. Refer to figure 3.3. Use a screwdriver to secure the module into the slot.

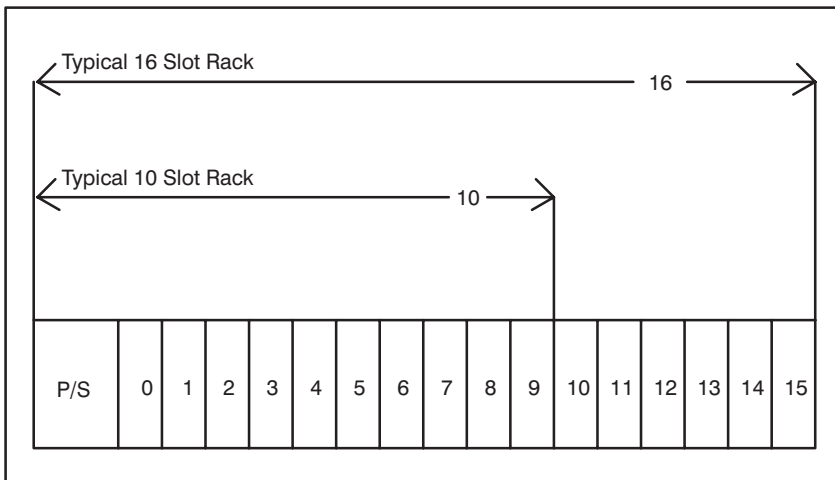

Figure 3.3- Rack Slot Numbers

- Step 5. Connect the D-shell on the end of the field wires to the connector on the faceplate of the module. Use a screwdriver to secure the connector to the module.
- Step 6. Turn on power to the system.
- Step 7. Verify the installation by checking the status of the seven-segment LED and the "OK" light. When the power is turned on, the module will automatically execute its power-up diagnostics. After the module has finished its diagnostics, the seven-segment LED on the faceplate should be off if the diagnostics were completed successfully. The link is configured for 4800 baud on power-up. The green "OK" light should be on in either case.

Step 8. Connect the programmer to the system and run the ReSource Software. Use the I/O MONITOR function.

If a baud rate other than 4800 is required, configure the serial port by writing the baud rate used by the transmitting device to register 21 and then writing the value 255 to register 20. The seven-segment LED should now be blank.

Monitor registers 14,16,17 and 18 using the ReSource Software. Register 14 should be changing at the rate that messages are being received.

### **3.3 Module Replacement**

Use the following procedure to replace a module:

- Step 1. Turn off power to the rack and all connections.
- Step 2. Use a screwdriver to loosen the screws holding the connector to the module. Remove the connector from the module.
- Step 3. Loosen the screws that hold the module in the rack. Remove the module from the slot in the rack.
- Step 4. Place the module in the anti-static bag it came in, being careful not to touch the connectors on the back of the module. Place the module in the cardboard shipping container.
- Step 5. Take the new module out of the anti-static bag, being careful not to touch the connectors on the back of the module.
- Step 6. Insert the module into the desired slot in the rack. Use a screwdriver to secure the module into the slot.
- Step 7. Attach the D-shell connector to the mating half on the module. Make certain that the connector is the proper one for this module. Use a screwdriver to secure the connector to the module.
- Step 8. Turn on power to the rack.





# 4.0 PROGRAMMING

This section describes how data is organized in the module and provides examples of how the module is accessed by the application software. For more detailed information refer to the AutoMax Enhanced BASIC Language Instruction Manual (J-3675).

## 4.1 Register Organization

The Toledo Scale Interface module contains a dual port memory that can be accessed by your application software as well as the microprocessor that controls the module. The dual port memory contains the control and status information as well as the Toledo Scale data. See figure 4.1 for the dual port memory map.

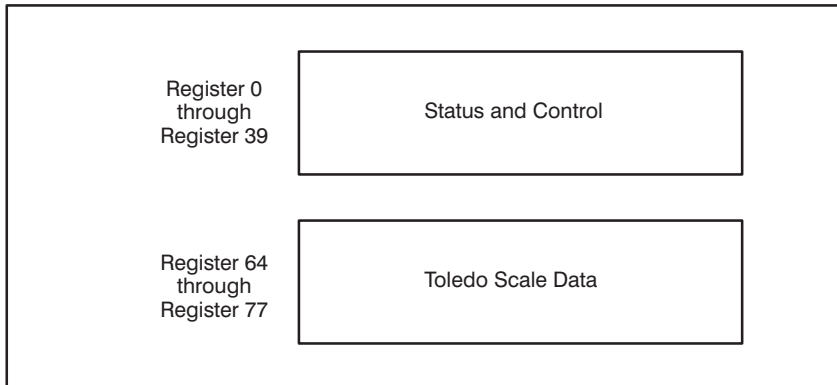

Figure 4.1- Dual Port Memory Organization

### 4.1.1 Status and Control Registers

Use the status and control registers to configure the serial communication port and then monitor its operation. All registers are read-only with the exception of registers 20-39.

Register 4 contains the link configuration status. It will be set to "1" after you have properly configured the module. Refer to figure 4.2.

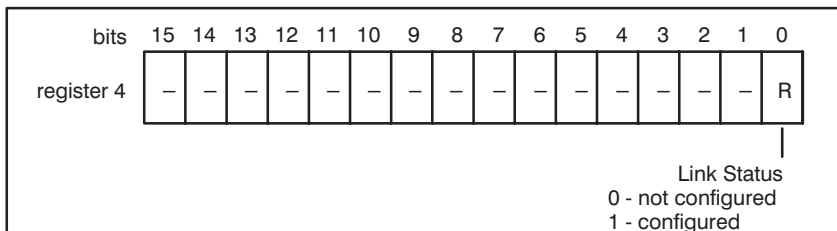

Figure 4.2- Status and Control Registers

Registers 14 through 18 contain information on the number and quality of messages received on the serial link. These counters will be incremented only if the start-of-message character (STX) is recognized by the module. Typically, these registers are used for diagnosing the serial link when problems occur. Refer to figure 4.3.

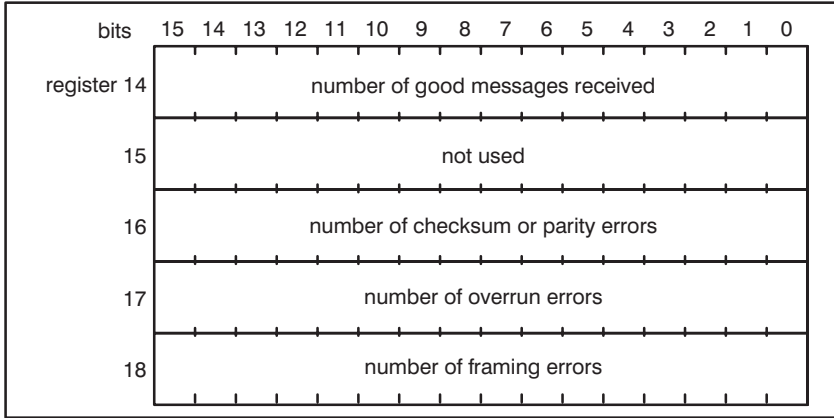

Figure 4.3- Receive Message Status

Register 20 is the configuration/update request register. The module continually monitors this register, and will re-configure the link anytime the update flag is set. Refer to figure 4.4.

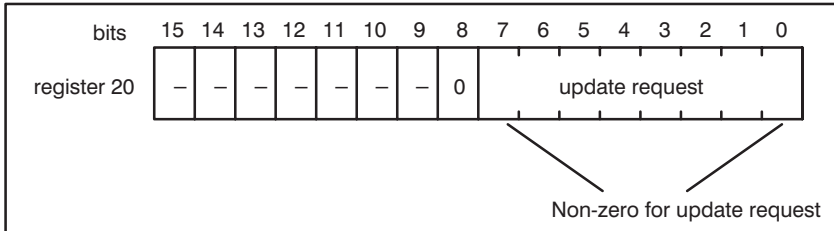

Figure 4.4 - Configuration/Update Request Register

Register 21 defines the serial port baud rate. The baud rate may be 1200, 2400, 4800, 9600 or 19,200. Refer to figure 4.5.

Register 22 defines the “link inactive” time-out value to aid the user in detecting link failures. Each time a start-of-message character (STX) is received, a timer is initiated with this value. If the timer expires, the next request by the application program for the scale data will result in “link inactive” status being returned. The time-out value is specified in seconds with a minimum value of one and a maximum value of 10. The default value is five. See figure 4.5.

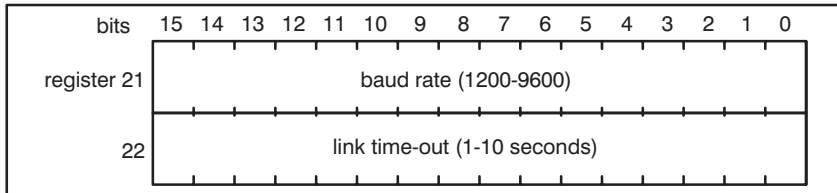

Figure 4.5- Control Registers

- |                 |   |                         |
|-----------------|---|-------------------------|
| register 23     | - | Setpoint Update Request |
| register 24, 25 | - | Setpoint #1             |
| register 26, 27 | - | Setpoint #2             |
| register 28, 29 | - | Setpoint #3             |
| register 30, 31 | - | Setpoint #4             |
| register 32, 33 | - | Setpoint #5             |
| register 34, 35 | - | Setpoint #6             |
| register 36, 37 | - | Setpoint #7             |
| register 38, 39 | - | Setpoint #8             |

Registers 24 through 39 may contain eight double-integer Setpoint values. The Setpoint values must be specified with the same implied decimal point as the Indicated Weight from the Indicator. The values are first stored in registers 24 to 39. Then register 23 must be set to a non-zero value to initiate the update in the Interface. The Interface software will set register 23 to a zero value after the update is complete. Setpoint values may be changed at any time, but you must set register 23 to initiate the update. The Setpoints are initialized to zero on power-up.

#### 4.1.2 Toledo Scale Data Registers

The Toledo Scale status and weight data registers contain the data transmitted from the Toledo Scale digital indicator. All registers are read-only with the exception of register 64.

Register 64 is used to initiate an update of registers 65-77. In order to read the scale data (status and weight), first set the request/status register to a value of one. Next, monitor the register for a value less than or equal to zero. A value of zero indicates valid data which may be read by the BASIC task. A negative value in the request/status register indicates an error condition. Refer to figure 4.6 for an explanation of error codes for register 64.

Data is received continuously by the module. The data is placed in dual port memory only when requested via the request/status register (register 64). The data that will be stored in dual port memory will be the last valid message that was received by the module. Registers 66-77 are not updated if an error status is returned.

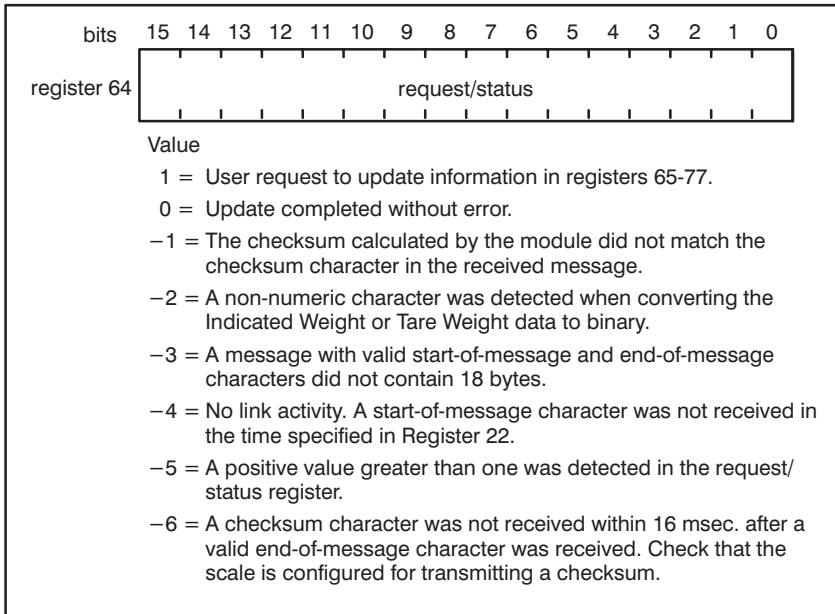

Figure 4.6 - Request/Status Register Error Codes

Register 65 is incremented by the module each time it receives a start-of-message character on the serial interface. The value will range from 0 - 255. Use this register to determine whether the data contained in registers 66-77 has changed from the last time it was read. Refer to figure 4.7.

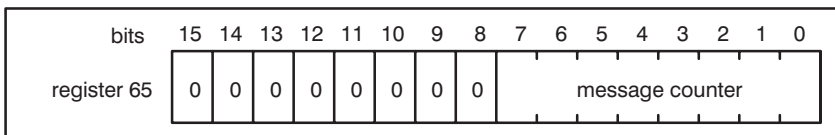

Figure 4.7- Message Counter Register

Registers 66-72 contain the data that was received in the last message from the Toledo Scale digital indicator.

Register 66 contains status byte "A". Refer to figure 4.8.

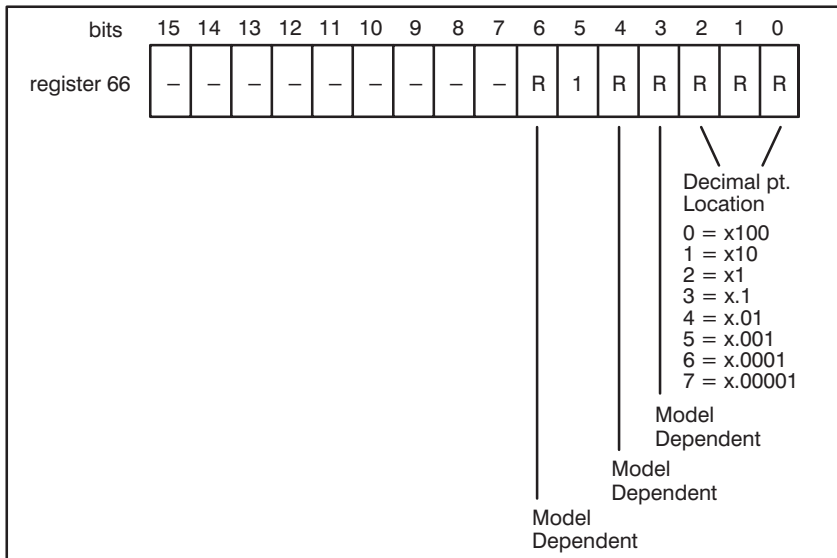

Figure 4.8- Status Byte "A"

Register 67 contains status byte "B". Refer to figure 4.9.

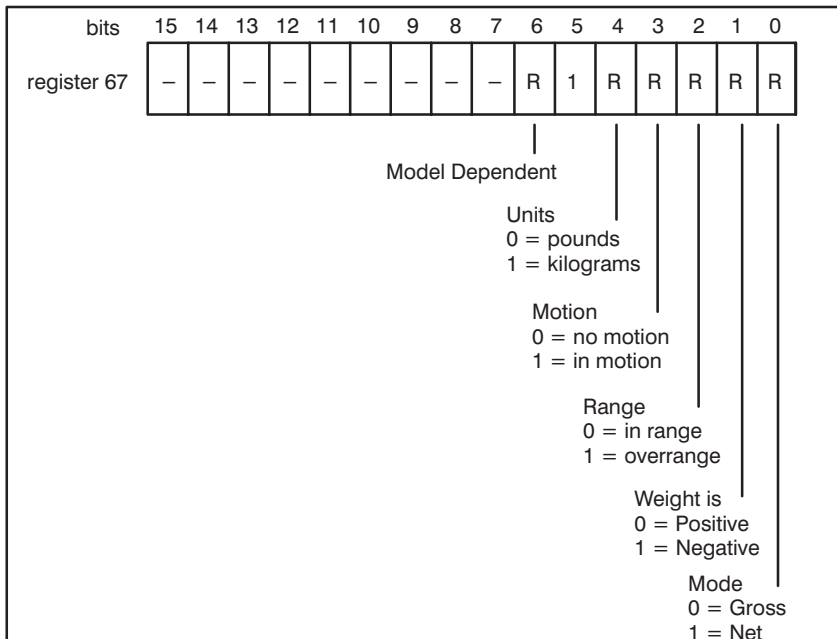

Figure 4.9- Status Byte "B"

Register 68 contains status byte "C". Refer to figure 4.10.

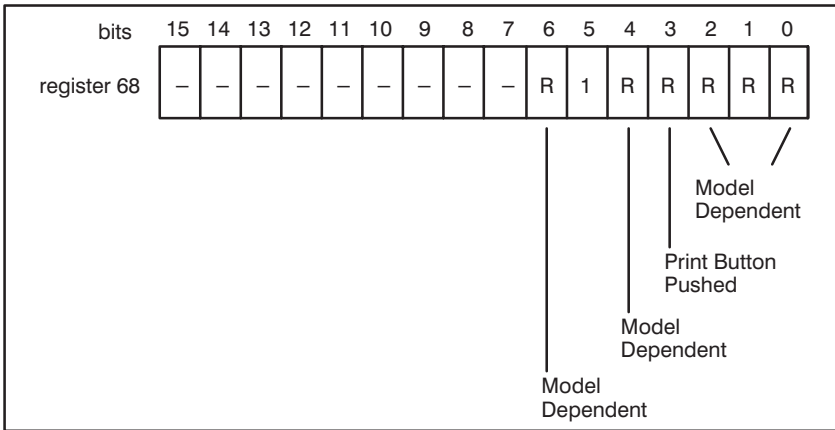

Figure 4.10- Status Byte "C"

Registers 69-72 contain the indicated weight and tare weight, respectively. These values are stored as 32-bit long integers. See figure 4.11.

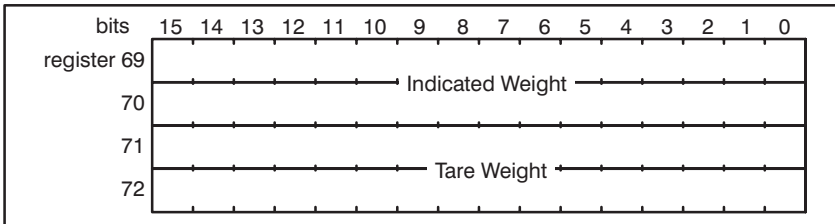

Figure 4.11- Weight and Tare Registers

- register 73, 74 - 'signed' Gross Weight
- register 75, 76 - absolute Gross Weight
- register 77 - Setpoint Comparison Flags

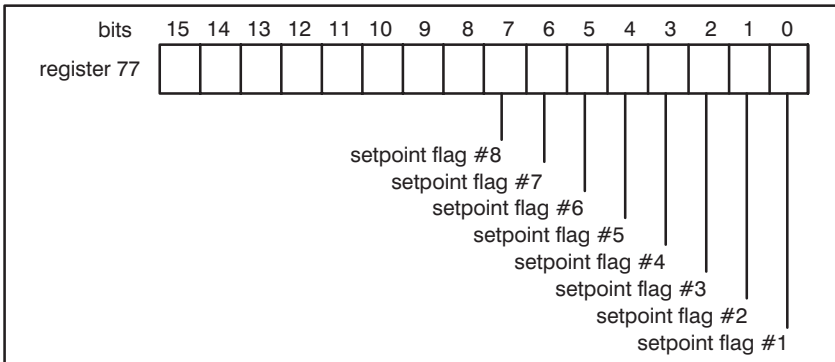

Figure 4.12- Setpoint Flag Register

Two Gross Weight calculations are made by the Interface software. The 'signed' Gross Weight is computed by first applying the 'sign' bit from Status Word 'B' to the Indicated Weight and then adding the Tare Weight. The result is stored as a double integer in registers 73, 74. The absolute value of the 'signed' Gross Weight is stored in registers 75, 76.

A comparison of the 'signed' Gross Weight is made with each of the eight Setpoints in registers 24-39. If the 'signed' Gross Weight is less than the Setpoint, the flag bit in register 77 is set to a 1 (TRUE); otherwise, the bit is set to zero (FALSE). The comparison flag for Setpoint #1 is in bit 0, Setpoint #2 in bit 1, etc.

## 4.2 Configuration

Before any application programs can be written, it is necessary to configure, or set, the definitions of system-wide variables, i.e. those that must be globally accessible to all tasks.

For DCS 5000 and AutoMax Version 2.1 and earlier, you define system-wide variables by writing a Configuration task. For AutoMax Version 3.0 and later, you define system-wide variables using the AutoMax Programming Executive. After these variables are defined, you can generate the configuration file automatically, which eliminates the requirement to write a configuration task for the rack. If you are using AutoMax version 2.1 or earlier, refer to Appendix E for examples that show how to define variables in the configuration task. If you are using AutoMax Version 3.0 or later, see the AutoMax Programming Executive (J-3750) for information about configuring variables.

## 4.3 Reading Data in Application Tasks

The frequency with which tasks read their inputs depends on the language being used. Ladder logic and control block tasks read inputs once at the beginning of each scan and write outputs once at the end of each scan, regardless of how often the inputs are referenced in the task. BASIC tasks read an input and write an output for each reference throughout the scan.

In order for the interface module to be referenced by application software it is necessary to assign symbolic names to the registers on the module. In AutoMax Version 2.1 and earlier, this is accomplished by IODEF statements in the configuration task. Refer to Appendix E for an example. In AutoMax Version 3.0 and later, you can assign symbolic names using the Programming Executive.

Each application task that references the symbolic names assigned to the interface module must declare those names COMMON.

### 4.3.1 Configuring the Module

The module must be configured whenever you turn on power to the system or change the baud rate of the serial interface. If the module has not been configured, it will display the letter “C” on its LED. The following is an example of the BASIC statements required in an application task to configure the module.

```
400 COMMON LINK_STATUS@           \!Link configuration status
410 COMMON LINK_CONF%             \!Link configuration request
420 COMMON BAUD_RATE%             \!Baud rate
430 COMMON RQST_STATUS%           \!Message request
440 COMMON MSG_NO%                \!Message number
450 COMMON STATUS_A%              \!Status byte A
480 COMMON INDICATED_WT!          \!Indicated weight
490 COMMON TARE_WEIGHT!           \!Tare weight
600 LOCAL OLD_MSG_NO%             \!Old data check
610 LOCAL WEIGHT                   \!Weight in eng units
620 LOCAL TARE                    \!Tare weight in eng units
630 LOCAL EXPONENT                \!Power of ten scaling
1000 REM
1010 REM Initialize Interface - Execute this section only 1 time
1020 REM
1030 BAUD_RATE% = 9600
1040 LINK_CONF% = 00FFH           \!Request link configuration
1050 DELAY 1 TICK                 \!Wait for link config.
1060 IF NOT LINK_STATUS@ THEN 1050
1070 OLD_MSG_NO% = -1             \!For "old" data check
```

### 4.3.2 Reading the Data

The following is an example of the BASIC statements required to read the data from the module:

```
2000 RQST_STATUS% = 1             \! Set request flag for data
2010 DELAY 1 TICK
2020 IF RQST_STATUS% = 1 THEN 2010 \! Check for returned status
2030 IF RQST_STATUS% < 0 THEN 3000 \! Branch if error
2047 REM
2048 REM Valid data, process weight data
2049 REM
2050 IF MSG_NO% = OLD_MSG_NO% THEN 2110
2055 REM                           \! If old data, skip conversion
2060 OLD_MSG_NO% = MSG_NO%         \! Update old message number
2070 EXPONENT=10.**(2-(STATUS_A% AND 07H))
2075 REM                           \! Get power of 10
2080 IF EXPONENT > 1. THEN EXPONENT = 1.0
2085 REM                           \! If x1 or more, no scaling req'd
2090 WEIGHT = INDICATED_WT! * EXPONENT
2095 REM                           \! Convert weight data to REAL
2100 TARE = TARE_WEIGHT! * EXPONENT
2105 REM                           \! & account for decimal point
2110 !
2500 !
3000 ! Error status returned
3100 !
3200 ! Decode error status
3300 END
```



## 4.4 Message Transmission Time

The time required for a message to be transmitted is:

Time (in milliseconds) = 198,000/Baud Rate

The module requires less than 1 millisecond to receive the message and store it in dual port memory.

## 4.5 Restrictions

This section describes limitations and restrictions on the use of this module.

### 4.5.1 Remote Racks

This module should not be used in a remote rack.

### 4.5.2 Reading Toledo Scale Data

Registers 65-72 should not be read without first performing a "request update" via register 64.

### 4.5.3 Writing Data to Registers

This module contains registers that are read only. Attempts to write to them will cause a bus error (severe system error). The following are examples from programs that write to the module and should therefore be avoided if they involve read-only registers:

- a. Referencing the module from the coil in a ladder logic task.
- b. Referencing the module on the left side of an equal sign in a LET statement in a control block or BASIC task.
- c. Referencing the module as an output in a control block function.



# 5.0 DIAGNOSTICS AND TROUBLESHOOTING

This section explains how to troubleshoot the module and field connections. If you cannot determine the problem, the unit is not user-serviceable.

## 5.1 No Activity on Serial Line

**Problem:** No data is being received on the serial line. You can confirm this by monitoring the values in register 14-18. If they do not change regularly, no data is being received. The possible causes of this error are a programming error or a malfunctioning module. It is also possible that the transmitter is malfunctioning, or that the serial line is not connected or is connected to the wrong transmitter. Use the following procedure to isolate the problem:

**Step 1.** Verify that the module has been configured correctly.

The LED on the module faceplate should be blank. If it is, verify that the baud rate in register 21 is the same as the baud rate of the transmitting device.

If the LED on the module faceplate displays the letter "C," the module has not been configured correctly. Review your rack configuration as well as the programming statements to configure the module.

**Step 2.** Verify that the module is connected to the correct transmitter.

Check the cabling between the module and the transmitter. Make certain that the proper devices are connected together, that all the connections are secure, and that the proper signals are connected together. Refer to Appendix C for D-shell connections and to figure 4 for the proper connector on the transmitting device.

**Step 3.** Verify that the serial link is working.

Connect an oscilloscope to the transmitter terminals on the Toledo Scale digital indicator. The oscilloscope should display a square wave with periods equal to the values in figure 5.1 when the device is transmitting. If it does not display a square wave, the transmitter is malfunctioning.

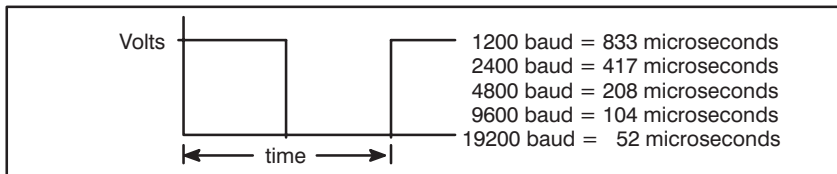

Figure 5.1 - Pulse Time for Different Baud Rates

If the transmitter is working correctly, repeat this process on the connector on the interface module. If the oscilloscope displays a square wave again, the interface module is malfunctioning. Otherwise, troubleshoot the cabling.

## 5.2 Incorrect Data

**Problem:** The data is either always off, always on, or different than expected. The possible causes of this problem are a module in the wrong slot, a programming error, or a malfunctioning module. It is also possible that the input is not wired or is wired to the wrong device. Use the following procedure to isolate the problem:

- Step 1. Verify that the serial link is working correctly.  
Refer to the procedure in section 5.1.
- Step 2. Verify that the input module is in the correct slot.  
Refer to figure 3.3. Verify that the slot number being referenced agrees with the slot number defined in the configuration. Verify that the register numbers that have been assigned to the variables agree with the definitions in the configuration task.
- Step 3. Verify that the module can be accessed.  
Connect the programmer to the system and run the ReSource Software.  
Stop all tasks that may be running.  
Using the I/O MONITOR, toggle register 64 and verify that the data in register 65 changes and that the data in registers 65-72 is the correct scale data.  
If the programmer is able to read the data, the problem lies in the application software (refer to step 4). If the programmer cannot read the data, the problem lies in the hardware (refer to step 5).
- Step 4. Verify that the user application program is correct.  
Verify that the application program that uses the symbolic names assigned to the module has defined them as COMMON.  
Compare your application program with the examples given in sections 4.3.2 and 4.3.3. In your program, make certain that you are toggling register 64 before attempting to read the data in registers 65-72.
- Step 5. Verify that the hardware is working correctly.  
Verify the hardware functionality by systematically swapping out modules. After each swap, if the problem is not corrected, replace the original module before swapping out the next module.  
First, replace the input module. Next, replace the Processor module (s). If the problem persists, take all of the modules out the backplane except one Processor module and the interface module. If the problem is now corrected, one of the other modules in the rack is malfunctioning. Reconnect the other modules one at a

time until the problem reappears. If none of these tests reveals the problem, replace the backplane.

## 5.3 Bus Error

Problem: A “31” or “51”-“54” appear on the processor module’s LED. These error messages indicate that there was a bus error when the system attempted to access the module. The possible causes of this error are a missing module, a module in the wrong slot, or a malfunctioning module. It is also possible that the user is attempting to write to read-only registers on the module. Use the following procedure to isolate a bus error:

- Step 1. Verify that the input module is in the correct slot.  
Refer to figure 3.3. Verify that the slot number being referenced agrees with the slot number defined in the configuration task. Verify that the register numbers that have been assigned to the variables agree with the definitions in the configuration task.
- Step 2. Verify that the module can be accessed.  
Connect the programmer to the system and run the ReSource Software. Monitor register 14 on the module. If the programmer is able to monitor it, the problem lies in the application software (refer to step 3). If the programmer cannot monitor the register, the problem lies in the hardware (refer to step 4).
- Step 3. Verify that the user application program is correct.  
The error log will contain the number of the BASIC program statement in which the error occurred. Verify that any variables in a statement identified in the error log that alter the contents of memory refer only to registers 20 thru 39. These are the only registers that can be written to by an application task.
- Step 4. Verify that the hardware is working correctly.  
Systematically swap out the the interface module, the Processor module (s), and the backplane. After each swap, determine if the problem has been corrected before swapping out the next item.



# Appendix A

## Technical Specifications

### Ambient Conditions

- Storage temperature: -40C - 85C
- Operating temperature: 0C - 60C
- Humidity:: 5-90% non-condensing

### Maximum Module Power Dissipation

- 13 Watts

### Dimensions

- Height: 11.75 inches
- Width: 1.25 inches
- Depth: 7.375 inches

### System Power Requirements

- 5 Volts: 2400 mA
- +12 Volts: 53 mA
- -12 Volts: 8 mA

### Serial Line Characteristics

- Transmission mode: 7-bit ASCII
- Checksum: Required
- Parity: Even
- Start bits: 1
- Bits/character : 11
- Stop bits: 2
- Baud rate: 1200, 2400, 4800, 9600, 19200  
(user-configurable)





# Appendix B

## Module Block Diagram

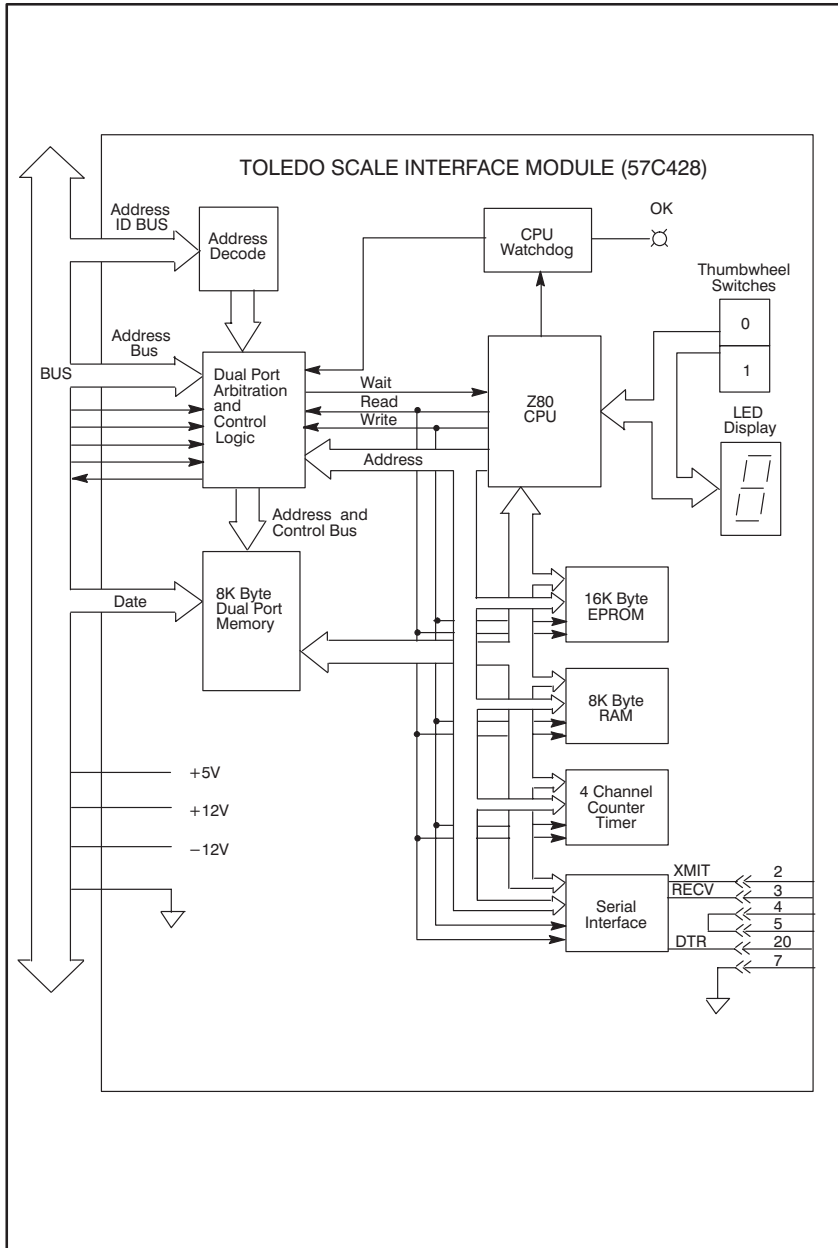



# Appendix C

## Field Connections

Connector "Gateway"

Conn. Pin No.	Function
3	RxD Receive
7	Signal Ground



# Appendix D

## Toledo Scale Continuous Output Message Format

A valid message begins with a start-of-message character (ASCII STX). The message contains three bytes of status information, six bytes of indicated weight, and six bytes of tare weight. The message is terminated by a carriage return. A single byte checksum follows the carriage return. The checksum is calculated by taking the 2's complement of the sum of bits 0-6 of all characters preceding the checksum character.

1	2	3	4	5	6	7	8	9	10	11	12	13	14	15	16	17	18
S	SW	SW	SW	Indicated Weight						Tare Weight						C	CK
T				X	X	X	X	X	X	X	X	X	X	X	X	R	SM
X	A	B	C	(MSD)			(LSD)			(MSD)			(LSD)				



# Appendix E

## Defining Variables in the Configuration Task

Before any application programs can be written, it is necessary to configure, or set, the definitions of system-wide variables, i.e. those that must be globally accessible to all tasks.

This section describes how to configure the system variables on this input module. Refer to the figure below. Note that this procedure is only used if you are using the Programming Executive Software Version 2.1 or earlier.

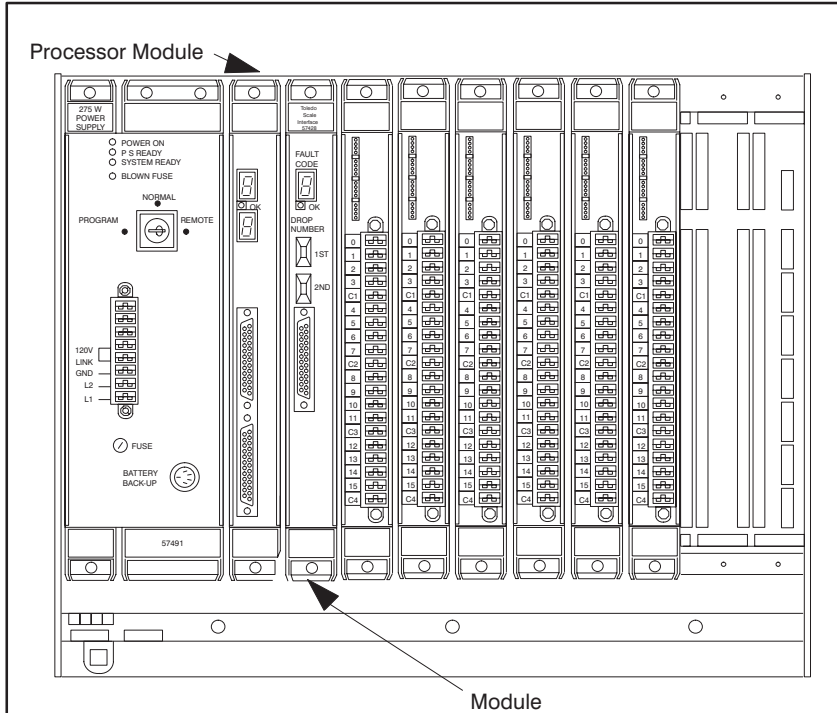

Module in a Local Rack

### 32 Bit Register Reference

Use the following method to reference 32 bits as a single register. 32 bit register reference is commonly used to read indicated weight or tare weight. The symbolic name of each register should be as meaningful as possible.

nnnnn IODEF SYMBOLIC\_NAME![ SLOT=s, REGISTER=r]

When referenced as a long register of 32 bits, register "r" is the most significant 16 bits and register "r+1" is the least significant 16 bits.

## 16 Bit Register Reference

Use the following method to reference a 16 bit register. 16 bit register reference is commonly used to reference message number and status. The symbolic name of each register should be as meaningful as possible.

```
nnnnn IODEF SYMBOLIC_NAME%[ SLOT=s, REGISTER=r]
```

## Bit Reference

Use the following method to reference individual inputs on the module. Single bit reference is used to reference link status. The symbolic name of each bit should be as meaningful as possible.

```
nnnnn IODEF SYMBOLIC_NAME@[ SLOT=s, REGISTER=r, BIT=b]
```

where:

nnnnn – BASIC statement number. This number may range from 1–32767.

SYMBOLIC\_NAME! – A symbolic name chosen by the user and ending with (!). This indicates a long integer data type and all references will access registers r and r+1.

SYMBOLIC\_NAME% – A symbolic name chosen by the user and ending with (%). This indicates an integer data type and all references will access register “r”.

SYMBOLIC\_NAME@ – A symbolic name chosen by the user and ending with (@). This indicates a boolean data type and all references will access bit number “b” in the register “r”.

SLOT – Slot number that the module is plugged into. This number may range from 0–15.

REGISTER – Specifies the register that is being referenced. This number may range from 0–72.

BIT – Used with boolean data types only. Specifies the bit in the register that is being referenced. This number may range from 0–15.

## Examples of I/O Definitions

The following statement assigns the symbolic name TARE\_WEIGHT! to register 71 on the module located in slot 4:

```
1020 IODEF TARE_WEIGHT![ SLOT=4, REGISTER=71]
```

The following statement assigns the symbolic name LINK\_STATUS@ to register 4, bit 0, on the module located in slot 7:

```
2050 IODEF LINK_STATUS@[ SLOT=7, REGISTER=4, BIT=0]
```

## Sample Configuration Task

The following is an example of a configuration task for the interface module:

```
1000 IODEF LINK_STATUS@[ SLOT = 5, REGISTER = 4, BIT=0 ]
1010 IODEF LINK_CONF%[ SLOT = 5, REGISTER = 20 ]
1020 IODEF BAUD_RATE%[ SLOT = 5, REGISTER = 21 ]
1030 IODEF RQST_STATUS%[ SLOT = 5, REGISTER = 64 ]
1040 IODEF MSG_NO%[ SLOT = 5, REGISTER = 65 ]
1050 IODEF STATUS_A%[ SLOT = 5, REGISTER = 66 ]
1060 IODEF STATUS_B%[ SLOT = 5, REGISTER = 67 ]
1070 IODEF STATUS_C%[ SLOT = 5, REGISTER = 68 ]
1080 IODEF INDICATED_WT![ SLOT = 5, REGISTER = 69 ]
1090 IODEF TARE_WEIGHT![ SLOT = 5, REGISTER = 71 ]
```

Each application task that references the symbolic names assigned to the interface module must declare those names COMMON.





## **For additional information**

1 Allen-Bradley Drive

Mayfield Heights, Ohio 44124 USA

Tel: (800) 241-2886 or (440) 646-3599

<http://www.reliance.com/automax>

[www.rockwellautomation.com](http://www.rockwellautomation.com)

### **Corporate Headquarters**

Rockwell Automation, 777 East Wisconsin Avenue, Suite 1400, Milwaukee, WI, 53202-5302 USA, Tel: (1) 414.212.5200, Fax: (1) 414.212.5201

### **Headquarters for Allen-Bradley Products, Rockwell Software Products and Global Manufacturing Solutions**

Americas: Rockwell Automation, 1201 South Second Street, Milwaukee, WI 53204-2496 USA, Tel: (1) 414.382.2000, Fax: (1) 414.382.4444

Europe/Middle East/Africa: Rockwell Automation SA/NV, Vorstlaan/Boulevard du Souverain 36, 1170 Brussels, Belgium, Tel: (32) 2 663 0600, Fax: (32) 2 663 0640

Asia Pacific: Rockwell Automation, 27/F Citicorp Centre, 18 Whitfield Road, Causeway Bay, Hong Kong, Tel: (852) 2887 4788, Fax: (852) 2508 1846

### **Headquarters for Dodge and Reliance Electric Products**

Americas: Rockwell Automation, 6040 Ponders Court, Greenville, SC 29615-4617 USA, Tel: (1) 864.297.4800, Fax: (1) 864.281.2433

Europe/Middle East/Africa: Rockwell Automation, Brühlstraße 22, D-74834 Elztal-Dallau, Germany, Tel: (49) 6261 9410, Fax: (49) 6261 17741

Asia Pacific: Rockwell Automation, 55 Newton Road, #11-01/02 Revenue House, Singapore 307987, Tel: (65) 6356-9077, Fax: (65) 6356-9011