

Product Catalog



**EUROTHERM
DRIVES**



AC DRIVES

DC DRIVES

MOTORS

LINK

SERVO DRIVES



EUROTHERM DRIVES

PRODUCT CATALOG

Welcome to the Eurotherm Drives Product Catalog. Once again even more new products have been introduced to further establish Eurotherm Drives as the leading world specialist in variable speed drive motor control. Our tremendous selection means that we can offer the right drive for your application - every time, without compromise; drives that are filled with innovative, easy to use features, providing elegant solutions at economical prices at the highest levels of reliability.

[AC Drives](#)

[DC Drives](#)

[Motors](#)

[Link](#)

[Servo Drives](#)

**Eurotherm Drives –
choices not
compromises.**

CONTENTS

PRODUCT SELECTOR

AC PRODUCT SELECTOR

	0	0.5Hp	5Hp	50Hp	600Hp
Low Cost, General Purpose Inverter	650 Series 0.3 to 150Hp				P6
Full Feature, 3-in-1 Drive with Unrivaled Flexibility and Performance	690+ Integrator 0.3 to 500Hp				P10

DC PRODUCT SELECTOR

	0	2Hp	20Hp	200Hp	3000Hp
Low Cost Motor Control with Tachometer or Voltage Feedback	506/507/508 Series 0 - 2Hp				P14
Ideal Lower Power Drive with Isolated Control Circuits	512C Series 0-7.5Hp				P14
Four Quadrant Regenerative Drive to Complement the 512C Series	514C Series 0-7.5Hp				P15
A Total Drive System in a Single Module Offering Outstanding Flexibility	590+ Integrator 1-2000Hp				P16

SERVO PRODUCT SELECTOR

	0	0.5A	5A	50A	500A
Basic Brushless Servo Drive with Integral Motion Controller	631 Series 1-6A				P38
Full Feature Brushless Servo Drive with Integral Motion Controller	635/637+ Series 2-32A				P38
Complete Range of Customizable Servo Motors and Drives	Motors 0-300A				P41

SECTION 1 AC DRIVES

6	650 Series Inverters 0.3 to 150Hp	10	690+ Integrator Series Open Loop, Sensorless and Closed Loop (Flux Vector) Inverters to 500Hp
---	-----------------------------------	----	---

SECTION 2 DC DRIVES

14	506/507/508 Single-phase DC Drives Up to 2Hp	15	514C Single-phase Isolated Regenerative DC Drives Up to 7.5Hp	16	590+ Integrator Series Three-phase Regenerative and Non-Regenerative DC Drives 1 to 2000Hp
14	512C Single-phase Isolated Non-Regenerative DC Drives Up to 7.5Hp				

SECTION 3 ACCESSORIES

20	AC Accessories – Dynamic Braking Resistors	24	DC Accessories – 590+ DRV Control Transformer, Blower Motor Starter, Controller AC Fuse Kits	27	Fiber Optic Accessories - Plastic , Composite Fibers, Duplex, Single Strand and Glass Fiber Optic Cable	30	DC Drive/Motor Packages 1 to 1000Hp
21	AC Accessories – Three -Phase Line Reactors	25	DC Accessories - Armature Voltage Feedback Unit 5590, Diagnostic Unit 5570, 5401 Field Controller, Three-Phase Line Filter	28	General Accessories – Signal Isolators, 5530, Non-Contact Dancer Position Potentiometer, L5231 Fiber Optic Light Meter	32	Isolation Transformer Modifications
22	DC Accessories – Three -Phase Line Reactors, Three-Phase Lines for EMC, Armature DC Contactor	26	EMC Filters	29	General Accessories – 5703 Peer-to-Peer Comm. Module, 5507 Analog Panel Meters, Digital Panel Meter Type 5512	34	Software – ConfigEd Lite, Drive System Designer
23	DC Accessories – Dynamic Braking Resistors, Dynamic Braking Contact					34	Software – ConfigEd Lite Plus

SECTION 4 LINK

36	LINK Fiber Optic Based Drive and Process Control System
----	---

SECTION 5 SERVO DRIVES

38	631 Series 1 to 6A, 635/637 + 2 to 32 A	40	Accessories - 631/636/637	42	Digivex Series 50 to 300A
39	631/635/637 1 to 30A	41	Brushless Servo Motors 1 to 30A	43	Parvex Motors

SECTION 6 GENERAL INFORMATION

44	Drive Formula and Calculations	IBC	Worldwide Contact Addresses
----	--------------------------------	-----	-----------------------------

Welcome to the newest Eurotherm Drives Catalog. This catalog is filled with more new products than ever before.

When you need a drive, you want a company that has a wide enough product range with the application experience to meet your requirements. And whether you are a local end user or exporting machinery builder you want a company that will provide expert advice and support across the world. You want innovative, state of the art products that are easy to use and above all else, reliable - and you want tremendous value for money. In short you want to talk to Eurotherm Drives.

NEW

650 SERIES

AC v/Hz and Sensorless Vector Drives (0.3-150 Hp)

The 650 series is a highly compact range AC drives available at amazingly cost effective prices. They are simple to set up and install and are compatible with both single-phase (230V) and three-phase (380-460V) AC supplies. The 650 series is ideal for standard AC motor control applications where the functionality of more complex drives is unnecessary.

NEW

631 SERIES

AC Brushless Servo Drives and Motors (1-6A)

The 631 series is a range of low cost, compact brushless servo drives for use on 230 VAC supplies. But its size and cost are deceptive - each unit includes a powerful integral motion controller making the 631 ideal for modern high performance positioning applications and stepper drive replacement.

Packaged with a 631 drive, the NX motor completes your most economical solution for axis applications. The NX series is a new generation of compact servo motors with low inertia and very low cogging for high dynamic performance.

NEW

DRIVE SYSTEM DESIGNER SOFTWARE

DSD - Drive System Designer - is like no other drive design software. DSD with Auto Configure allows you to quickly design a complete, multi-drive system. From a standard, single line diagram of the machine or process, the user simply enters basic parameters (like line speed, tension) and functions (like winder, nip drive) and the software does the rest. Now, a project that would have taken days of expert design and debugging time is completed within minutes.



NEW

INTEGRATOR SERIES

690+ 3-in-1 AC Drives (1-500 Hp) and 590+ DC Drives (1-2000 Hp)



The Integrator series is a single family of both AC (690+) and DC (590+) drives offering the benefit of common programming, Fieldbus communications and software tools across both technologies.

The 690+ AC series is user configurable for basic open-loop (v/Hz), sensorless vector or full closed-loop, flux vector control. The 590+ series is available in "DRV" format incorporating all fuses, AC supply contactor, and optional fan blower starter and control transformer within the same footprint area.

NEW

SMALLEST 150 HP AC DRIVE

650 and 690+ AC Drive (150 Hp)



You've made no compromises when you use our new 75 through 150 Hp AC drive package. Its rugged design, standard built-in AC line reactor and tiny (29 inch by 10 inch) footprint will make your projects an even greater success. Whether built as a 650 or a 690+ drive, it will fit your needs exactly.

NEW

500 HP DC DRIVE GETS SMALLER

590+ DC Drive (200-900 Hp)

The new Integrator series 590+ frame 4 packs all the power of our 500 Hp drive into smaller design. The fan is now internal providing ultra-quiet operation and simpler installation. In fact, this compact (27.6 x 10.0 x 13.9) drive package replaces sizes from 200 Hp through 500 Hp making Eurotherm Drives and even better fit. With line reactors, two units are paralleled, which makes the frame 5, to provide up to 1580A output, extending the range to 900 Hp.





The Eurotherm Drives Story

Eurotherm Drives is an industry leading manufacturer of AC, DC and Servo drives and motors. We are renowned for our wide range of reliable, innovative, state of the art products, applications experience, and global support.

Established in 1974, we were originally called Shackleton System Drives (SSD). We changed our name to Eurotherm Drives in 1990. For almost 30 years, we have supplied drives to the leading OEMs and end users in industry.

In 2000, Parvex joined Eurotherm Drives, which further expanded our product offering. Now we offer a complete line of the world's most advanced AC, DC, and servo drives and motors. These products bring the right mix of features and functionality that were developed from over two and a half decades of worldwide industry experience.

Our LINK fiber-optic, real-time network provides unmatched integrated system control. It en-

ables drives, touchscreen operator stations, I/O modules, PLCs, and supervisory computers to work seamlessly over a single fiber-optic connection.

Eurotherm Drives products provide coordinated system solutions for industries such as converting and web handling, wire, plastics, paper, textiles, metals, and motion control. Eurotherm Drives is also a leading supplier for complete drive, motor, and control solutions for the ski-lift industry.

A worldwide network of Eurotherm companies and agents ensure you get expert application and service support in over 40 countries. You can install our products wherever you are, with the confidence of full back up and support.

Whether your goal is to upgrade one motor section or automate an entire plant, Eurotherm Drives provides the ideal, one-stop solution.



Systems

Complementing our complete range of AC and DC drive products, Eurotherm Drives offers a world-class drive system design service. With over two and a half decades of industry experience in converting, wire and cable, metals, paper, plastics and many more, we have built a considerable reputation for excellence of system design and manufacture.

Our highly experienced team of applications engineers provides design services for custom drive systems used in a wide variety of industries. It produces simple to complex, turnkey drive systems with integrated PLCs and SCADA control.

A standardized, functional design approach makes it possible to construct, test, and document complex systems quickly and economically, yet to a high quality standard. Our UL, CSA and CE certified panel shop builds systems that meet stringent local and world demands and the witness testing program ensures trouble-free installations.



Service

To support installations worldwide, we offer field service and start-up assistance through domestic and international teams of service engineers. The Eurotherm Drives network of certified service houses ensures our customers can get on-site support anywhere and anytime they need it.

An experienced staff of product specialists provides an around-the-clock product support service to help customers solve problems whenever they occur.

Support

Worldwide sales offices assure local support all over the globe. They assure our customers have products available locally to support their manufacturing operations.



Training

Eurotherm Drives provides factory, on-site, and other customized training for all of its products. This training ensures our customers learn from the experts on selecting, applying, calibrating, and troubleshooting our products.

Classes include a mixture of lecture and hands-on instruction.



650 **NEW** 0.3 to 150 Hp v/Hz and Sensorless Vector

The 650 series inverters provide simple, no-fuss speed control of standard three-phase AC motors from 0.3 to 150 Hp. Sensorless vector versions (standard above 10 Hp) provide exceptional dynamic response. They are full of useful features including pre-programmed applications - all designed to simplify set-up, installation and operation.

With the 650 Series, you are in control of your application immediately - no complicated set-up procedures, no confusing menu navigation; just quick and easy operation straight from the box.



...SIMPLE TO INSTALL
...SIMPLE TO SET-UP
...SIMPLE TO OPERATE

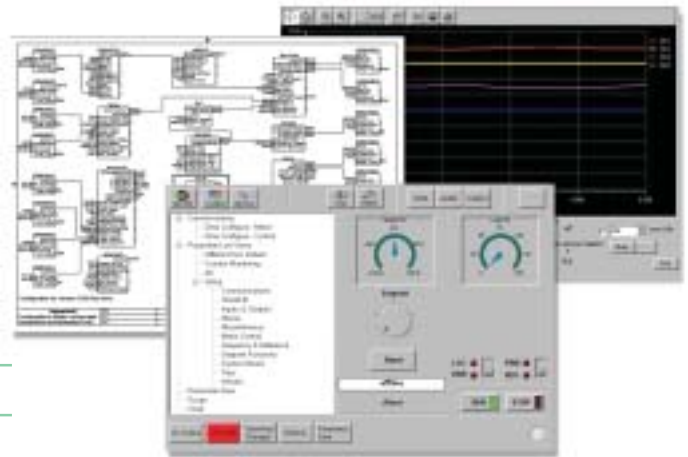

EXTREMELY SIMPLE SET-UP AND OPERATION

PRE-PROGRAMMED APPLICATIONS

LOCAL OR REMOTE MOUNTABLE KEYPAD

EXCEPTIONALLY COMPACT DESIGN, DIN MOUNTABLE TO 10HP

INTERNAL EMC COMPLIANT FILTERS

HIGH TORQUE SENSORLESS VECTOR OPTION

ConfigEd Lite Plus

Lets you...

- Set up all parameters
- Autotune your application
- Chart key variables ON LINE!

220-240V Single and Three-Phase Controllers

Type	Heavy Duty Nominal Output		Standard Duty Nominal Output		Frame Size	Built-in Choke	Built-in Brake Switch	
	Power KW/Hp	Current (A)	Power KW/Hp	Current (A)				
650**/00F3/230/SNN*	0.25/0.3	1.5	-	-	1	-	-	
650**/00F5/230/SNN*	0.3/0.5	2.2						
650**/00F7/230/SNN*	0.55/0.75	3						
650**/0001/230/SNN*	0.75/1	4			2			
650**/0002/230/SNN*	1.5/2	7						
650**/0003/230/SBN	2.2/3	9.6						
650**/0005/230/SBN	4.0/5	16.4			3			C
650V/0007/230/1BN	5.5/7.5	22	75/10	28				
650V/0010/230/1BN	7.5/10	28				11/15	42	
650V/0015/230/1BN	11/15	42			15/20			54
650V/0020/230/1BN	15/20	54	18/25	68				
650V/0025/230/1BN	18/25	68				-	-	
650V/0030/230/1BN	22/30	80			30/40			104
650V/0040/230/CBN	30/40	104	37/50	130				
650V/0050/230/CBN	37/50	130				45/60	154	
650V/0060/230/CBN	45/60	154			55/75			192

*Single-phase supply only.

**Replace the 650 with 650V to select the sensorless vector option.

380-460V Three-Phase Controllers

Type	Heavy Duty Nominal Output		Standard Duty Nominal Output		Frame Size	Built-in Choke	Built-in Brake Switch
	Power KW/Hp	Current (A)	Power KW/Hp	Current (A)			
650**/00F5/460/SBN	0.3/0.5	1.5	-	-	2	-	YES
650**/00F7/460/SBN	0.55/0.75	2					
650**/0001/460/SBN	0.75/1	2.5					
650**/0002/460/SBN	1.5/2	4.5			3		
650**/0003/460/SBN	2.2/3	5.5					
650**/0005/460/SBN	3.7/5	9					
650**/0007/460/SBN	5.5/7.5	12			C		
650**/0010/460/SBN	7.5/10	16	18/25	34			
650V/0015/460/1BN	11/15	21				22/30	45
650V/0020C/460/1BN	15/20	27			30/40		
650V/0025/460/1BN	18/25	38	37/50	65			
650V/0030/460/1BN	22/30	45				45/60	87
650V/0040D/460/1BN	30/40	52			55/75		
650V/0050/460/1BN	37/50	73	75/100	125			
650V/0060/460/1BN	45/60	87				90/125	156
650V/0075/460/CBN	55/75	105			91/150		
650V/0100/460/CBN	75/100	125	-	-			
650V/0125/460/CBN	90/125	156					
650V/0150/460/CBN	91/150	180					

**Replace the 650 with 650V to select the sensorless vector option.

Options

Remote mount keypad and Serial port standard on all 650V model drives (for frames 1, 2, and 3, select 650V and replace the 'S' in the part number with a 'R' to select this option)

For example, change 650/0010/460/SBN to 650V/0010/460/RBN for a standard, 10 Hp, 650 sensorless vector controller with a remote mountable keypad.

Brake Switch (optional above 15 Hp) (replace the 'B' in the part number with a 'N' to omit this option)

For example, change 650V/0040/460/SBN to 650V/0040/460/SNN for a standard, 40 Hp, 650 sensorless vector controller with a brake switch.

Internal EMC filter (up to 10 Hp) (replace the 'N' in the part number with a 'F' to select this option)

For example, change 650/0010/460/SBN to 650V/0010/460/SBF for a 10 Hp, 650 sensorless vector controller with an internally mounted EMC filter.

For external footprint style **EMC filters** (15 to 150 Hp), see page 26.

650 0.3 to 150 Hp

TECHNICAL SPECIFICATION

Power Supply - Single phase units; 220-240 VAC $\pm 10\%$; 50-60 Hz $\pm 5\%$

Three phase units; 380-460 VAC $\pm 10\%$; 50-60 Hz $\pm 5\%$

Ambient - 0-40°C (32-104°F); derate 2% per °C to 50°C (122°F) maximum

Altitude - 1000m (3280 ft.) ASL; derate 1% per 100m (328 ft.) above 1000m (3280 ft.) to 5000m (16400 ft.) max.

Overload - 150% for 30 seconds (heavy duty)
115% for 30 seconds (standard duty)

Output Frequency - 0-240 Hz

Environmental Protection - IP20

Analog Inputs - 2; Speed control (0-10V, 4-20mA)

Analog Output - 1; User configurable for DEMAND / CURRENT / PID ERROR / RAISE-LOWER OUTPUT (0-10V)

Digital Inputs - 2; User configurable start/stop/direction/pre-set speeds (8)

Digital Input/Outputs - 2; User configurable as inputs or outputs

Digital Relay Outputs - 1; User configurable relay outputs (1A @ 240V)

All digital outputs configurable for AT SPEED / AT ZERO SPEED / RUNNING / HEALTHY / TRIPPED.

Motor Thermistor Input

POWER SUPPLIES

Digital I/O supply - 24 VDC (50 mA)

Analog reference supply - 10 VDC (10 mA)

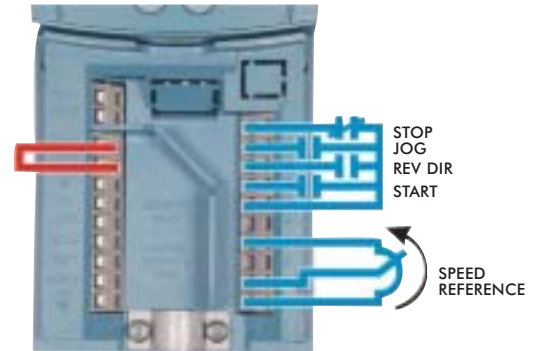

FRAME 1,2,3

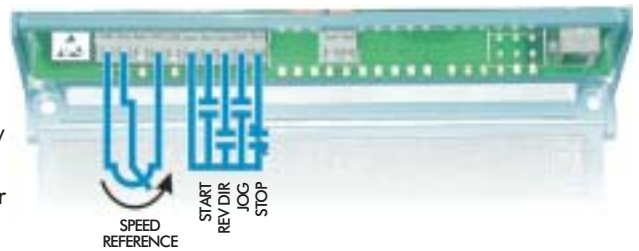

FRAME C-F

Dimensions

Frame Size	Size			Mounting			Weight (Kg/Lbs)
	H	W	D	H1	H2	W1	
1	142/5.6	74/2.9	142/5.6	132/5.2	-	-	0.9/1.9
2	200/7.9	74/2.9	173/6.8	188/7.4			14/3.1
3	259/10.2	97/3.8	200/7.9	242/9.5			2.7/5.9
C	348/13.7	201/7.9	208/8.1	335/13.2	150/5.9	-	9.3/20
D	453/17.8	252/9.9	245/9.6	471/17.3			17.4/38
E	668/26.3	257/10.1	312/12.12	630/24.8			22.5/50
F	720/28.9	257/10.1	349/13.7	700/27.5			29/64

All dimensions in millimeters/inches.

STANDARDS

The 650 series meets European and North American standards when installed in accordance with relevant product manual.

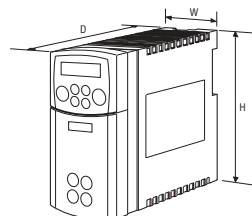

FRAME 1,2 & 3

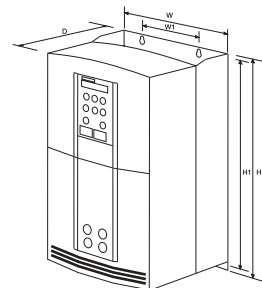

FRAME C & D

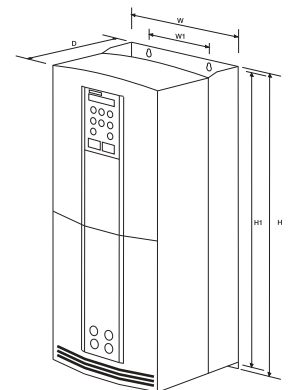

FRAME E & F

SIMPLE TO USE

- No languages to learn
- Reduced menus show only key parameters
- Software programmable with remote keypad option



SIMPLE TO SETUP

Select from five internal programs to control your application or manually configure the drive as required. The programs configure the drive's inputs, outputs and parameter list automatically. The applications include:

- **Basic Speed Control** - voltage or current speed demand with digital start/stop and direction.

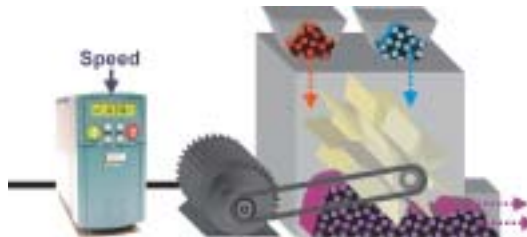

- **Manual/Auto Control** - switch between a local and remote speed demand signal.



- **Preset Speeds** - select up to 8 pre-programmed speeds using digital inputs.

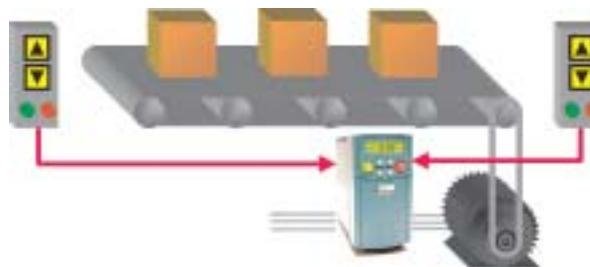

- **Raise/Lower** - increase and decrease speed from raise and lower digital inputs.

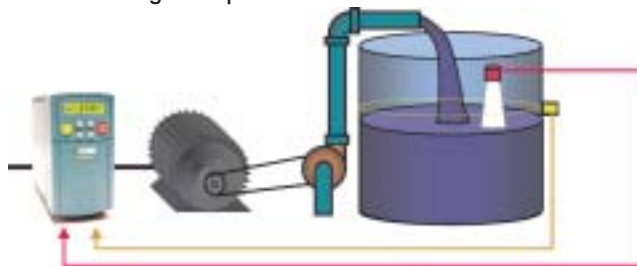

- **PID Control** - control pressure, flow, temperature or other variable by monitor transducer feedback.



SIMPLE TO OPERATE

The 6511 keypad is used for configuring and controlling the drive. Its design includes a back-lit LCD, 4-digit readout with indicators for motor rotating and direction, local/remote operation, parameter type (diagnostic or setup), and units. The standard keypad is drive mounted and removable.

The remote keypad option lets the keypad mount up to three meters from the drive. It also includes a P3 port that can be used to program the drive with CELite+ software.

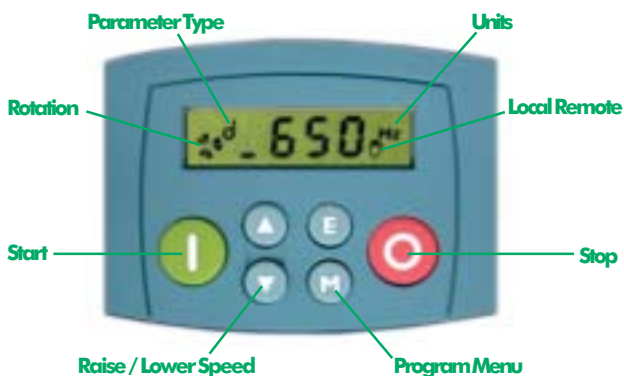

690+ Integrator

0.3 to 500 Hp

3-in-1

The 690+ series is a single range of AC drives designed to meet the requirements of all variable speed applications from simple, single-motor speed control through to the most sophisticated, integrated multi-drive systems. At the heart of the 690+ is a highly advanced, 32-bit microprocessor based, motor control algorithm, to which can be added a host of control options that allow you to tailor the drive to meet your exact requirements.

Three-phase (380-460V) ratings are available from 0.5 to 500 Hp and (220-240V) ratings from 0.5 to 75 Hp.



... USER FRIENDLY

... NETWORK FRIENDLY

... SIMPLY POWERFUL

OPEN LOOP (v/Hz), SENSORLESS VECTOR AND CLOSED LOOP VECTOR IN A SINGLE DRIVE

REGENERATIVE CAPABILITY FOR COMMON BUS SUPPLIES

COMMON PROGRAMMING, FIELDBUS AND SOFTWARE TOOLS WITH THE 590+ DC INTEGRATOR SERIES

DUAL RATED FOR CONSTANT OR QUADRATIC 'VARIABLE' TORQUE APPLICATIONS

IP20, IP40 (NEMA 1) AND IP54 (NEMA12) PROTECTION OPTIONS

BUILT-IN CHOKES PROTECT AGAINST LINE SURGES AND SPIKES

FUNCTION BLOCK PROGRAMMING



ConfigEd Lite Plus

Lets you...

- Set up all parameters
- Autotune your application
- Chart key variables ON LINE!

208-240V Single and Three-Phase Controllers

Type	Constant Torque Rating** Nominal Output		Variable (Fan) Torque Rating** Nominal Output		Frame Size	Built-in Choke	Built-in Brake Switch
	Power KW/Hp	Current (A)	Power KW/Hp	Current (A)			
690+0001/230/1BN*	0.75/1	4.3	-	-	B	-	YES
690+0002/230/1BN*	1.5/2	8					
690+0003/230/1BN*	2.2/3	10.5					
690+0005/230/1BN	3.7/5	16					
690+0007/230/1BN	5.5/7.5	22	7.5/10	28	C	DC	Optional
690+0010/230/1BN	7.5/10	28	11/15	42			
690+0015/230/1BN	11/15	42	15/20	54	D		
690+0020/230/1BN	15/20	54	18/25	68			
690+0025/230/1BN	18/25	68	-	-	E		
690+0030/230/1BN	22/30	80	30/40	104			
690+0040/230/1BN	30/40	104	37/50	130	F	AC	
690+0050/230/1BN	37/50	130	45/60	154			
690+0060/230/CBN	45/60	154	55/75	192			

* Add a '-1' suffix for controllers using a single-phase supply. ** All horsepower ratings assume a 1800 RPM base speed motor.

380-460V Three-Phase Controllers

Type	Constant Torque Rating** Nominal Output		Variable (Fan) Torque Rating** Nominal Output		Frame Size	Built-in Choke	Built-in Brake Switch
	Power KW/Hp	Current (A)	Power KW/Hp	Current (A)			
690+0001/460/1BN	0.75/1	2.5	-	-	B	-	YES
690+0002/460/1BN	1.5/2	4.5					
690+0003/460/1BN	2.2/3	5.5					
690+0005/460/1BN	4.0/5	9.5					
690+0007B/460/1BN	5.5/7.5	11					
690+0010B/460/1BN	6.0/10	14					
690+0015/460/1BN	11/15	21	15/20	27	C	DC	Optional
690+0020C/460/1BN	15/20	27	18/25	34			
690+0025/460/1BN	18/25	38	22/30	45	D		
690+0030/460/1BN	22/30	45	30/40	52			
690+0040D/460/1BN	30/40	52	37/50	65	E	AC	
690+0050/460/1BN	37/50	73	45/60	87			
690+0060/460/1BN	45/60	87	55/75	105	F		
690+0075/460/CBN	55/75	100	75/100	125			
690+0100/460/CBN	75/100	125	90/125	156	G	External	
690+0125/460/CBN	90/125	156	90/150	180			
690+0150/460/CBN	91/150	180	-	-	H		
690+0175/460/CBN	110/175	216	132/200	260			
690+0200/460/CBN	132/200	250	150/250	302	J		
690+0250/460/CBN	160/250	316	200/300	361			
690+0300/460/CBN	180/300	361	220/350	420			
690+0350/460/CBN	200/350	420	250/400	480			
690+0400/460/CBN	250/400	480	300/450	545			
690+0500/460/CBN	280/500	590	315/550	650			

* Add a '-1' suffix for controllers using a single-phase supply. ** All horsepower ratings assume a 1800 RPM base speed motor.

Options & Accessories

Miscellaneous Remote mounting bezel and 3m (10 ft.) lead 6052

Technology Boxes 690+ Size B 690+ All Others

Profibus 6053/PROF/00 6055/PROF/00

Modbus/RS422/RS485/EIbisynch 6053/EI00/00 6055/EI00/00

Link 6053/LINK/00 6055/LINK/00

DeviceNet 6053/DNET/00 6055/DNET/00

Encoder feedback LA467461 6054-00

Wall Mount IP40 (NEMA 1) Covers included to 60 Hp (not available above 60 Hp)

Dynamic Braking Switch - optional above 15 Hp (replace the 'B' in the part number with a 'N' to remove this option)

For example, change 690+0020/460/1BN to 690+0020/460/1NN for a standard, 20 Hp, 690+ controller without a Dynamic Braking Switch installed. Drives do not include resistors for braking, for details on resistors, please refer to page 20.

System Expansion Module - Factory installed option. (Replace the 'N' in the part number with a 'S' to select this option)

For example, change 690+0020/460/1BN to 690+0020/460/1BS for a standard, 20 Hp, 690+ controller with a System Expansion Module installed.

Internal EMC filter (up to 10 Hp) (Add a '-F' suffix to select this option) For example, change 690+0005/460/1BN to 690+0005/460/1BN-F for a 5

Hp, 690+ controller with an internally mounted EMC filter. Optional external **EMC filters** and **line chokes** please refer to pages 26 and 21.

690+ Integrator

0.3 to 500 Hp

TECHNICAL SPECIFICATION

Power Supply - Single or three phase units; 220-240 VAC ±10%; 50-60 Hz ±5%

Three phase units; 380- 460 VAC ±10%; 50-60 Hz ±5%

Ambient - Constant Torque rating - 0-45°C (32-113°F) (40°C (104°F) with IP40 cover); Variable Torque rating - 0-40°C (32-104°F) (35°C (95°F) with IP40 cover); derate 2% per °C to 50°C (122°F) maximum

Altitude - 1000m (3280 ft.) ASL; derate 1% per 100m (328 ft.) above 1000m (3280 ft.) to 5000m (16400 ft.) max.

Overload - 150% for 60 seconds, 180% for 0.5 second (frames C through F only) (constant torque rating) 115% for 60 seconds (variable torque rating)

Output Frequency - 0-480 Hz

Switching Frequency - Frame B 3, 6 or 9 kHz; Frame C, D, E and F 3 or 6 kHz (all with audibly silent switching pattern)

Environmental Protection - IP20

Analog Inputs - 4; User configurable (10 bit (12 bit with systems expansion module) (0-10V, ±10V, 0-20mA, 4-20mA))

Analog Outputs - 3; User configurable (10 bit 0-10V, ±10V, 0-20mA, 4-20mA)

Digital Inputs - 7; User configurable (nominal 24V DC)

Digital Outputs - 3; User configurable relay outputs (3A @ 230 VAC)

Motor Thermistor Input

POWER SUPPLIES

Digital I/O supply – 24 VDC (150 mA)

Analog reference supply – +10 VDC, -10 VDC (10 mA)

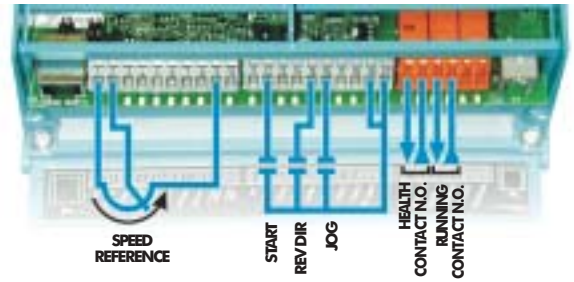

SYSTEMS EXPANSION MODULE

An optional add-on systems expansion module is available for more advanced applications including phase locking between drives, electronic line shaft and register control. Key features include:

- 5 configurable digital inputs/outputs
- 2 encoder inputs
- 2 high speed register mark inputs
- Improved analog input resolution (from 10 to 12 bit plus sign)

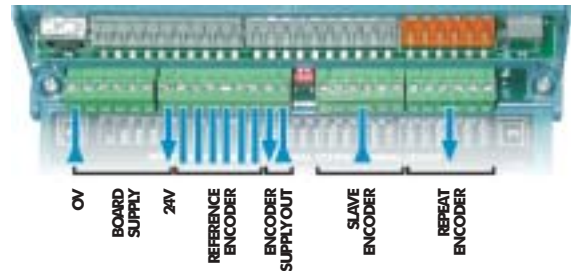

Dimensions

Frame Size	Size			Mounting			Weight (Kg/Lbs)
	H	W	D	H1	H2	W1	
B	233/9.1	171/6.9	181/7.1	233/8.7			4.3/9.5
C	348/13.7	201/7.9	208/8.1	335/13.2			9.3/20
D	453/17.8	252/9.9	245/9.6	471/17.3	—		17.4/38
E	668/26.3	257/10.1	312/12.2	630/24.8		150/5.9	22.5/50
F	720/28.9	257/10.1	349/13.7	700/27.5			29/64
G	1042/41.0	569/22.4				420/16.5	108/238
H	1177/46.3	684/27.0	465/18.3	300/11.8	16/0.6	536/21.1	138/304
J	1288/50.7	789/31.1				641/25.2	176/387

All dimensions in millimeters/inches.

The 690+ series meets European and North American standards when installed in accordance with relevant product manual.

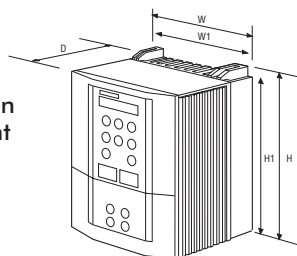

FRAME B

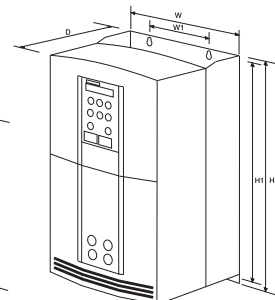

FRAME C, D, E & F

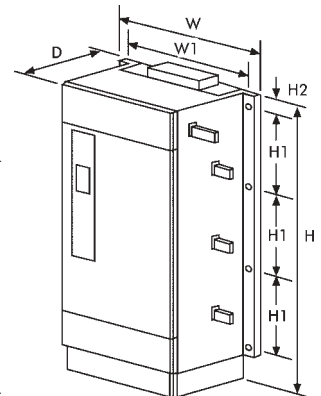

FRAME G, H & J

USER FRIENDLY

6901 Man Machine Interface

The 6901 Man Machine Interface is used for setting-up, programming and controlling the drive. It has been ergonomically designed with a back-lit, 32-character, alphanumeric display to provide intuitive access to all functions in a logical menu driven format.

- Straight-forward 4-button menu structure
- Provides local control - even on networked systems
- Password and function lockout
- Detachable for control panel mounting
- Same keypad as on DC drives



Multi-lingual plain language
English • French • German • Spanish • Italian

Quick set-up
Bypasses advanced features for simple applications

Autotune
Custom tunes drive for full torque without turning motor shaft

Customized screens
Customize to display application-specific engineering units

Easy Configuration
Connect any function block to any other



- LINK
- DeviceNet
- ControlNet
- ProfiBus
- ModBus
- ModBus Plus
- Ethernet
- CANopen
- LonWorks

690+ Integrator 0.3 to 500 Hp

NETWORK FRIENDLY

Communication techboxes plug onto the drive and allow users to monitor and control the drive on many industry standard fieldbus networks.

SIMPLY POWERFUL!

With built-in function blocks to meet any application.

- PID Control
- Diameter Calculator
- Taper Calculator
- Torque Calculator
- Speed Demand Calculator
- Compensation Calculator
- Setpoint Summing Junction

Contains several pre-engineered applications that configure entire sections like 'Speed Winders' with one selection.

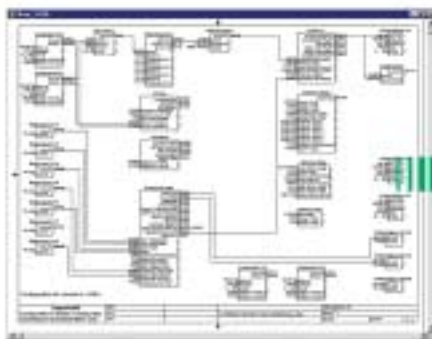

506/507/508

Up to 2 Hp

The 506, 507 and 508 series drives break new ground in value for money DC motor control. Available in 3, 6 or 12A armature ratings, the feature packed minimum footprint design is ideal for speed or torque control of permanent magnet or shunt wound DC motors from single-phase supplies.



INPUTS/OUTPUTS

Analog Inputs - 5; Speed Setpoint / Auxiliary Setpoint / Torque or Current Limit / Zero Speed Threshold (+10V); Tachometer Feedback (200 VDC max.)

Digital Inputs - 1; Start-Run (+10V)

Digital Outputs - 2; Healthy / Zero Speed Interlock (16V 50mA)

Reference Supplies - 1; +10 VDC

LED Diagnostics - Power On, Health

Potentiometer Adjustments

Maximum speed / Minimum speed / Current limit / Acceleration ramp (1-15 seconds) / Deceleration ramp (1-15 seconds) / IR compensation / Speed stability

Switch Adjustments

Armature Current Calibration / Armature Voltage Calibration / Tachometer Feedback / Supply Voltage Select

TORQUE OR SPEED CONTROL

IP20 PROTECTED COVERS

DIN RAIL MOUNTING

SWITCH SELECTABLE 110 OR 230 VAC SUPPLY

SWITCH SELECTABLE TACHOMETER OR ARMATURE VOLTAGE FEEDBACK

512C Non-Regen

Up to 7.5 Hp

Isolated control circuitry, a host of user facilities and extremely linear control loop make the 512C ideal for single motor or multi-drive low power applications. Designed for use on single phase supplies, the 512C is suitable for controlling permanent magnet or wound field dc motors in speed or torque control.



INPUTS/OUTPUTS

Analog Inputs - 4; Speed Setpoint / Auxiliary Setpoint / Torque or Current Limit (+10V); Tachometer Feedback (+350 VDC max.)

Analog Outputs - 4; Speed / Ramp Setpoint / Total Setpoint (+10 VDC); Armature Current (+5 VDC)

Digital Inputs - 2; Start-Run (+10 to +24 VDC) / Stall Override (+10 VDC)

Digital Outputs - 2; Health / Zero Speed (24V) 50mA Reference Supplies - 2; -10 VDC / +10 VDC

LED Diagnostics - Power On, Stall Trip, Overcurrent Trip
Extremely linear control loops

Potentiometer Adjustments

Maximum speed / Minimum speed / Current limit / Acceleration ramp (0-40 seconds) / Deceleration ramp (0-40 seconds) IR compensation / Speed stability / Zero speed offset

Switch Adjustments

Armature Current Calibration / Armature Voltage Calibration / Tachometer Feedback / At Zero Speed/Setpoint / Current Meter Output / Supply Voltage Select - Jumpers

TORQUE OR SPEED CONTROL

FULLY ISOLATED CONTROL CIRCUITS

MULTI INPUT SPEED AND CURRENT SETPOINTS

EXTREMELY LINEAR CONTROL LOOPS

514C Regen

Up to 7.5 Hp

The regenerative 514C DC drive offers full four-quadrant control of dc motors from single-phase supplies. As such it is ideal for applications involving overhauling loads or where rapid and accurate deceleration is required. Together with the non-regenerative 512C, they offer the perfect solution for lower power single motor and multi-drive applications.



INPUTS/OUTPUTS

Analog Inputs - 6; Speed Setpoint / Positive Trim Setpoint / Negative Trim Setpoint / Current Demand ($\pm 10V$); Current Limit ($\pm 7.5VDC$); Tachometer Feedback ($\pm 350VDC$ max.)

Analog Outputs - 5; Ramp Setpoint / Total Setpoint / Speed / Current Demand ($\pm 10V$); Current Output ($\pm 5V$)

Digital Inputs - 3; Start-Run / Enable (24 VDC) / Stall Override (+10VDC)

Digital Outputs - 2; Health / Zero Speed (24 VDC 50mA)

LED Diagnostics - Power On, Stall Trip, Overcurrent Trip, PLL Lock, Current Limit

Reference Supplies - 3; -10VDC / +10VDC / 24 VDC

Thermistor - 1

Potentiometer Adjustments

Maximum Speed / Current Limit / Acceleration Ramp (0-40 seconds) / Deceleration Ramp (0-40 seconds) / IR Compensation / Speed Loop Gain - Proportional / Speed Loop Gain - Integral / Current Gain - Proportional / Current Gain - Integral / Zero Speed Offset / Zero Speed Threshold

Switch Adjustments

Armature Current Calibration / Armature Voltage Calibration / Tachometer Feedback / At Zero Speed/Setpoint / Current / Meter Output / Ramp Isolate / Standstill Logic / Current Demand / Overcurrent Trip / Setpoint Comparator / Supply Voltage Select - Jumpers

FOUR QUADRANT REGENERATIVE CONTROL

TORQUE OR SPEED CONTROL

MANY SYSTEM FEATURES

EXTREMELY LINEAR CONTROL LOOPS

5570 DIAGNOSTIC COMPATIBLE

110-460V Single Phase Controller

Type	Nominal Output Power KW/Hp			Output	
	120V Supply	230V Supply	460V Supply	Current A	Field VDC
506/03/240	0.2/0.2	0.25/0.3	—	3	100/200
507/06/240	0.25/0.3	0.75/1	—	6	
508/12/240	0.75/1	1.5/2	—	12	
512C/040/000	0.2/0.25	0.3/0.5	1.1/0.75	4	
512C/080/000	0.3/0.5	0.7/1	2.2/1.5	8	
512C/160/000	0.75/1	2.2/3	4.5/5	16	
512C/320/000	1.5/2	3.7/5	9/7.5	32	
514C/040/000	0.2/0.25	0.3/0.5	1.1/0.75	4	
514C/080/000	0.3/0.5	0.7/1	2.2/1.5	8	
514C/160/000	0.75/1	2.2/3	4.5/5	16	
514C/320/000	1.5/2	3.7/5	9/7.5	32	

TECHNICAL SPECIFICATION

506/507/508

Power Supply - Main supply; 110-240 VAC $\pm 10\%$; Single-phase 50-60 Hz ± 5 Hz

512C/514C

Power Supply - Main supply; 110-480 VAC $\pm 10\%$; Single-phase 50-60 Hz ± 5 Hz

Auxiliary supply; 110-120, 220-240, or 380-415 (512C only) VAC $\pm 10\%$ user selectable.

All Drives

Field Supply - 0.9 X Main Supply voltage; 2A for 506/507/508 and 3A for 512C/514C maximum

Ambient - 0-45°C (32-113°F), up to 1000m (3280 ft) ASL without derating

Overload - 150% for 60 seconds

Dimensions

Type	Size			Mounting		Weight Kg/Lbs
	H	W	D	H1	W1	
506 and 507 508	140/5.5	104/4.1	79/3.1 89/3.5	140/5.5	50/2.0	0.6/1.3 0.7/1.5
512C (4 and 8 A)	240/9.4	160/6.2	90/3.3	210/8.21	48/5.8	1.5/3.3
512C (16A)			1.6/3.5			
512C (32A)			1.6/3.5			
514C (4 and 8 A)			1.6/3.5			
514C (16 and 32 A)			130/4.8			3/6.6

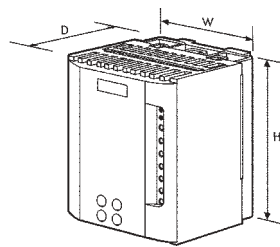

506/507/508

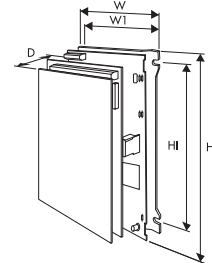

512C/514C

STANDARDS

The 506/507/508, 512C and 514C series meets European and North American standards when installed in accordance with relevant product manual.



590+ Integrator 1 to 2000 Hp

The Integrator Series is a single family of both AC drives (690+) and DC drives (590+) that provides the benefits of common programming, set-up and communications across both technologies. The 590+ Integrator series highly advanced DC drive meets the demands of the most complex motor control applications. Extensive application software (including winder control as standard) together with Function Block Programming and configurable I/O creates a total drive system in a single module.



...USER FRIENDLY
...NETWORK FRIENDLY
...SIMPLY POWERFUL

COMMON PROGRAMMING, SET-UP AND COMMUNICATIONS WITH 690+ AC INTEGRATOR SERIES

DRV OPTION WITH BUILT-IN CONTACTOR AND FUSES

SYSTEMS SPECIFICATION INCLUDING OPEN AND CLOSED LOOP WINDER CONTROL AS STANDARD

RATINGS UP TO 2700A AND SUPPLY VOLTAGES UP TO 660V

FUNCTION BLOCK PROGRAMMING BASED

INTERNAL CONTROLLED FIELD SUPPLY

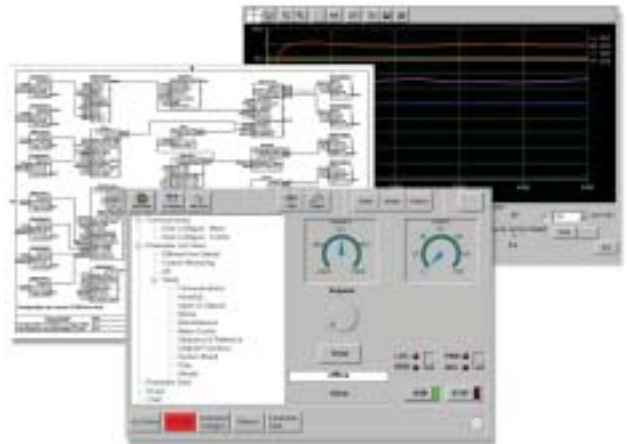

ConfigEd Lite Plus

Lets you...

- Set up all parameters
- Autotune your application
- Chart key variables ON LINE!

220-690V Three-Phase Drives and Controllers

Type		Nominal Output (Hp)				DRV Output Current (Amps)	Controller Output Current (Amps)	Frame Size
DRV*	Controller**	230V Supply	460V Supply	575V Supply***	660V Supply***			
955+8R0007	-	3	7.5	-	-	15	-	1
955+8R0020		10	20			35		
955+8R0030		15	30			55		
955+8R0040		20	40			70		
955+8R0050		25	50			90		
955+8R0060		30	60			110		
955+8R0075		40	75			125		
955+8R0100		50	100			165		
955+8R0125	590+0243/500	60	125	-	-	206	246	3
955+8R0150		75	150			246		
955+8R0200-D4****	590+0380/500	100	200	250	-	360	380	4
955+8R0250-D4****	590+0500/500	125	250	300	-	425	500	
955+8R0300-D4****		150	300	350	-	490	575	
955+8R0400-D4****	590+0725/500	200	400	500	-	700	725	
955+8R0500-D4	590+0830/500	250	500	600	-	815	830	
955+8R0600-D5	590+1580/500	-	600	700	-	1000	1580	5
955+8R0700-D5			700	900	-	1200		
955+8R0800-D5			800	1000	-	1334		
955+8R0900-D5			900	1100	-	1500		
955+8R0600	590+1050/500	600	700	900	-	1050	1050	
955+8R0900	590+1450/500	900	1000	1250	-	1450	1450	
955+8R1000	590+2000/500	1000	-	-	-	1600	2000	
955+8R1250		1250	1500	1750	-	2000		
955+8R1500	590+2400/500	1500	1750	2000	-	2400	2400	

*Replace 'R' for regenerative with 'N' for non-regenerative;

**Replace 590+ for regenerative with 591+ for non-regenerative

***Consult factory for 575, 660 and 690 VAC part numbers.

****Change suffix to 'A4' for AC contactor and D4 for DC contactor

Options

Keypad (included) 6901

Remote mounting bezel and lead 6052

Communication Technology Box

Profibus 6055/PROF/00

Modbus/RS422/RS485/EIBisynch 6055/E100/00

Link 6055/LINK/00

DeviceNet 6055/DNET/00

Speed Feedback Technology Box

Analog Tachometer AH385870U001

Encoder feedback AH387775U0xx*

* Replace 'xx' with 05, 12, 15, 24 for 5VDC, 12VDC, 15VDC or 24VDC respectively.

Microtach feedback for acrylic fiber AH386025U002

Microtach feedback for glass fiber AH386025U001

590+ DRV

A new concept in DC drive technology

The DRV includes all the peripheral power components associated with a DC drive system integrally fitted within a compact footprint area. DRVs include the following integrally mounted within the drive:

Contactors; AC line fuses; DC fuse (regenerative versions); Control/field fuses; Optional motor blower starter; Optional auxiliary control transformer.

All major power components are mounted under the hinged cover within the footprint area of the drive.

TECHNICAL SPECIFICATION

Power Supply – 220-500V (±10%) three phase; 500-690V (±10%) three phase >675A

Ambient – 0-45°C (32-113°F); 0-40°C (32-104°F) >246A; derate 1% per°C to 55°C (131°F) max.

Altitude – 500m (1640 ft.) ASL; derate 1% per 200m (656 ft.) above 500m to 5000m (16400 ft.) max.

Overload – 200% for 10 seconds, 150% for 30 seconds

INPUTS/OUTPUTS

Analog Inputs – 5; 1 - Speed Demand Setpoint (±10V); 4 – User configurable; (1 x 12 bit plus sign, 4 x 10 bit plus sign)

Analog Outputs – 3; 1 - Armature Current Output (±10V or 0-10V); 2 – User configurable (10 bit)

Digital Inputs – 9; Program Stop / Coast Stop / External Trip / Start-Run / 5 – User configurable (24V, max 15mA)

Digital Outputs – 3; User configurable (24V(max 30V) 100mA)

POWER SUPPLIES

Digital I/O Supply Total – 24 VDC (300 mA)

Analog Reference Supply – +10 VDC and –10 VDC (10 mA)

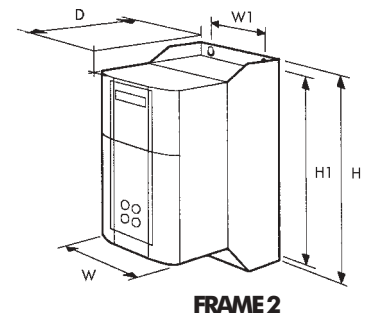
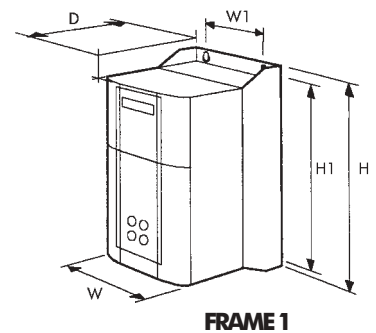
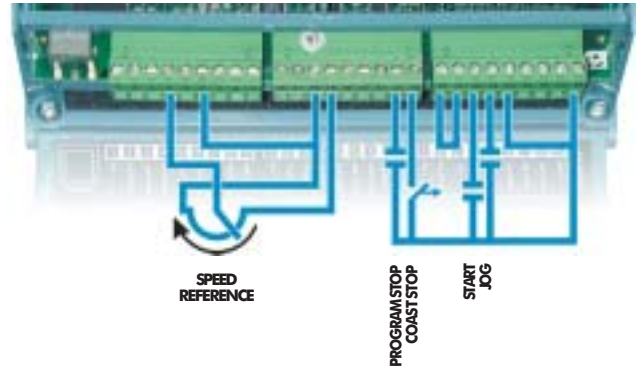

Dimensions

Frame Size	Size			Mounting			Weight Kg/Lbs	DRV H x W x D	Weight Kg/Lbs
	H	W	D	H1	H2	W1			
1	–	–	–	–	–	–	–	14.7 x 7.7 x 9	8.2/18
2	–	–	–	–	–	–	–	21.5 x 7.7 x 11.6	17/36
3	500/19.7	300/11.8	211/8.3	399/15.7	–	201/7.9	18.0/39.6	27 x 17 x 9.5	82/180
4	700/27.6	253/10.0	358/14.2	680/26.8	–	150/5.9	45.5/100	39 x 21.6 x 15.2	191/420
5	700/27.6	506/20.0	358/14.2	680/26.8	–	150/5.9	92.5/204	56 x 38 x 18.5	261/575
7aN	955/37.6	851/33.5	349/16.4	399/15.7	700/3.1	810/31.9	178.5/394	49 x 43 x 16	–/–
7aR	1407/55.4							69 x 43 x 16	
7bN	955/37.6							56 x 56 x 18	
7bR	1407/55.4							68 x 60 x 18	

All dimensions in millimeters/inches.

STANDARDS

The 590+ series meets European and North American standards when installed in accordance with relevant product manual.

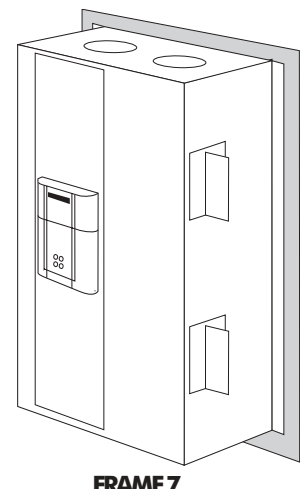
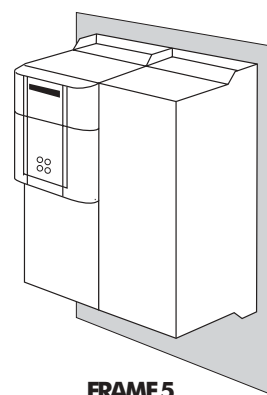
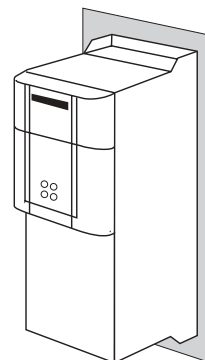
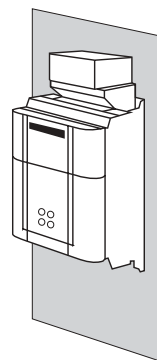

USER FRIENDLY

6901 MAN MACHINE INTERFACE

The 6901 Man Machine Interface is used for setting-up, programming and controlling the drive. It has been ergonomically designed with a back-lit, 32-character, alphanumeric display to provide intuitive access to all functions in a logical menu driven format.

Key features include:

- Detachable for 590+ or control panel mounting
- Local control of speed, start/stop, jog and direction
- Customized displays and legend
- Password and function lockout
- Quick set up menu



Multi-lingual plain language

English • French • German • Spanish • Italian

Quick set-up

Bypasses advanced features for simple applications

Autotune

Custom tunes drive for full torque without turning motor shaft

Customized screens

Customize to display application-specific engineering units

Easy Configuration

Connect any function block to any other



- LINK
- DeviceNet
- ControlNet
- ProfiBus
- ModBus
- ModBus Plus
- Ethernet
- CANopen
- LonWorks

NETWORK FRIENDLY

Communication techboxes plug onto the drive and allow users to monitor and control the drive on many industry standard fieldbus networks.

SIMPLY POWERFUL

FUNCTION BLOCK PROGRAMMING

Function Block Programming allows almost limitless combinations of user functions to be realized with ease. Out of the box the Function Blocks are pre-configured for immediate use. However by using the programming keypad or ConfigEd Lite Plus software (see page 35) each function can be interconnected to perform many other control actions. Some of the many function blocks are:

- Inputs
- Outputs
- Ramps
- Raise/Lower
- Winder Functions (diameter, torque, taper, compensations...)
- PID
- Field Control
- Jog/Slack control

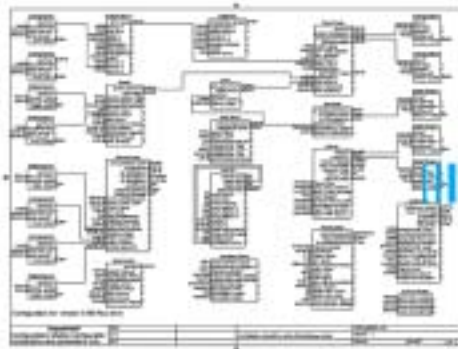

DCC DRIVES

AC Accessories Dynamic Braking Resistors

The Dynamic Braking Resistor kits were designed for stopping a motor at full load current from base speed with 6 times motor energy, four stops per hour (NEMA ICS 3-301.62 Dynamic Braking Stop Option).

AC inverters and flux vector controllers use dynamic braking resistors to dissipate excess energy from the DC bus caused by fast stopping or high supply voltages. This can be required even when the drive is stopped so the resistors operate, more-or-less, continuously.

The drive must be ordered with a braking module installed to use dynamic braking resistors.

These reactors are intended for use with the 690+ Series three-phase controllers. They may be used when voltage transformation or supply isolation is not required. Consult factory for resistors for older products.

COMPACT DESIGN

ROOF/PANEL MOUNTING

HORSEPOWER RATINGS FOR SIMPLIFIED SELECTION

INTEGRAL COVERS TO PREVENT INCIDENTAL CONTACT
WITH LIVE RESISTORS

230 VAC Dynamic Braking Kit w/Cover

Hp C.T.	Hp V.T.	Ohms	Amps	Catalog No.
1	1	45	2.5	CZ470637
1.5	2	45	2.5	CZ470637
2	3	45	2.5	CZ470637
3	5	45	2.5	CZ470637
5	7.5	27	3.6	CZ353192
7.5	10	15	5.3	CZ353193
15	15, 20	10	8.5	CZ353195
20	-	7.5	12	CZ353196
25	25	6	15	CZ353197
30	30, 40	5	18	CZ353198
40	50	3.5	27	CZ353199
50	60	2.4	30	CZ353200

460 VAC Dynamic Braking Resistor Kit w/Cover

Hp C.T.	Hp V.T.	Ohms	Amps	Catalog No.
1	1	100	1	CZ389853
2	2	100	1	CZ389853
3	3	100	1	CZ389853
5	7.5	100	1.6	CZ353179
7.5	10	100	1.6	CZ353179
10	15	54	3.6	CZ353181
15	20	54	3.6	CZ353181
20	25	30	5.3	CZ353182
25	30	30	5.3	CZ353182
30	40	30	5.3	CZ353182
40	50	26	7	CZ353183
50	60	18.4	9.2	CZ353185
60	75	12	13	CZ353186
75	100	9	18	CZ353188
100	125	7	22	CZ353189
125	150	5.5	27	CZ353190
150	-	5.5	27	CZ353190
175	200	3.22	41	CZ470036
200	250	2.6	46	CZ470037
250	300	2.2	50	CZ470038
300	350	2.2	50	CZ470038
350	400	1.67	57	CZ470039
400	450	1.37	63	CZ470040
450	500	1.37	63	CZ470040
500	550	1.12	70	CZ470041

COMPACT DESIGN

UL RECOGNISED AND CSA CERTIFIED

RATINGS FOR 230 AND 480 VAC SUPPLIES

ALL UNITS PROVIDE COMPRESSION TERMINALS

AC Accessories Three-Phase Line Reactors

These reactors are intended for use with the 690+ Series three-phase controllers. They may be used when voltage transformation or supply isolation is not required. Line reactors limit total radiated RF interference.

ACCESSORIES

230 VAC Reactors			
Hp	Amp	Description	Catalog No.
1	4	Reactor 3-phase 3.00 mh	C0470653
1.5	8	Reactor 3-phase 1.50 mh	C0353011
2	8	Reactor 3-phase 1.50 mh	C0353011
3	12	Reactor 3-phase 1.25 mh	C0470638
5	18	Reactor 3-phase 0.80 mh	C0353012
7.5	25	Reactor 3-phase 0.50 mh	C0353013
10	35	Reactor 3-phase 0.40 mh	C0353014
15	45	Reactor 3-phase 0.30 mh	C0353015
20	55	Reactor 3-phase 0.25 mh	C0353016
25	80	Reactor 3-phase 0.20 mh	C0353017
30	80	Reactor 3-phase 0.20 mh	C0353017
40	100	Reactor 3-phase 0.15 mh	C0470654
50	130	Reactor 3-phase 0.10 mh	C0353018
60	160	Reactor 3-phase 0.075 mh	C0470058

460 VAC Reactors			
Hp	Amp	Description	Catalog No.
1	2	Reactor 3-phase 12 mh	C0470650
2	4	Reactor 3-phase 6.50 mh	C0470651
3	8	Reactor 3-phase 5.00 mh	C0352782
5	8	Reactor 3-phase 3.00 mh	C0470652
7.5	12	Reactor 3-phase 2.50 mh	C0352783
10	18	Reactor 3-phase 1.50 mh	C0352785
15	25	Reactor 3-phase 1.20 mh	C0352786
20	35	Reactor 3-phase 0.80 mh	C0352901
25	35	Reactor 3-phase 0.80 mh	C0352901
30	45	Reactor 3-phase 0.70 mh	C0352902
40	55	Reactor 3-phase 0.50 mh	C0352903
50	80	Reactor 3-phase 0.40 mh	C0352904
60	80	Reactor 3-phase 0.40 mh	C0352904
75	100	Reactor 3-phase 0.30 mh	C0352905
100	130	Reactor 3-phase 0.20 mh	C0352906
125	160	Reactor 3-phase 0.15 mh	C0470057
150	200	Reactor 3-phase 0.11 mh	C0470045
200	250	Reactor 3-phase 0.09 mh	C0470046
250	320	Reactor 3-phase 0.075 mh	C0470047
300	400	Reactor 3-phase 0.06 mh	C0470048
350	500	Reactor 3-phase 0.05 mh	C0470049
400	500	Reactor 3-phase 0.05 mh	C0470049
500	600	Reactor 3-phase 0.04 mh	C0470050

Dimensions				
Catalog Number	Height	Width	Depth	Weight
C0353010	3.1(79)	6(152)	4.8(122)	8(3.2)
C0353011	3.1(79)	6(152)	4.8(122)	7(3.1)
C0353012	3.1(79)	6(152)	4.8(122)	9(4.0)
C0353013	3.4(86)	7.2(183)	5.6(142)	11(5.0)
C0353014	3.8(97)	7.2(183)	5.6(142)	14(6.3)
C0353015	4.8(122)	9.0(229)	7.0(178)	23(10)
C0353016	4.0(102)	9.0(229)	7.0(178)	24(11)
C0353017	5.6(142)	10.8(274)	8.2(208)	43(19)
C0353018	4.8(122)	9.0(229)	7.0(178)	30(14)
C0470650	2.8(71)	4.4(112)	4.0(102)	4(1.9)
C0470651	2.9(72)	4.4(112)	4.0(102)	4(1.9)
C0470652	3.1(79)	6.0(152)	4.8(122)	7(3.2)
C0470653	2.9(72)	4.4(112)	4.0(102)	4(1.9)
C0470654	5.6(142)	10.8(274)	8.2(208)	47(21)
C0353007	3.6(92)	4.4(112)	4.0(102)	6(2.7)
C0353009	3.4(86)	6.0(152)	3.4(86)	13(5.9)
C0352782	3.4(86)	6.0(152)	3.4(86)	5.0(11)
C0352783	3.1(79)	6.0(152)	4.8(122)	10(4.5)
C0352785	3.4(86)	6.0(152)	4.8(122)	12(5.4)
C0352786	3.4(86)	7.2(183)	5.6(142)	14(6.3)
C0352901	3.8(97)	7.2(183)	5.7(145)	16(7.3)
C0352902	4.8(122)	9.0(229)	7.0(178)	28(13)
C0352903	4.8(122)	9.0(229)	7.0(178)	27(12)
C0352904	5.6(142)	10.8(274)	8.3(211)	51(23)
C0352905	5.8(147)	10.8(274)	8.2(208)	51(23)
C0352906	5.8(147)	10.8(274)	8.4(213)	58(26)
C0470057	5.6(142)	10.8(274)	8.4(213)	22(50)
C0470045	6.3(160)	10.8(274)	8.4(213)	31(67)
C0470046	6.7(170)	14.4(366)	11.2(284)	45(106)
C0470047	6.7(170)	14.4(366)	11.2(284)	57(125)
C0470048	7.3(185)	14.4(366)	11.2(284)	71(155)
C0470049	7.8(198)	14.4(366)	11.3(287)	82(180)
C0470050	8.3(211)	14.4(366)	11.3(287)	96(210)

All dimensions are in inches (mm) and weights are in Lb.(Kg).

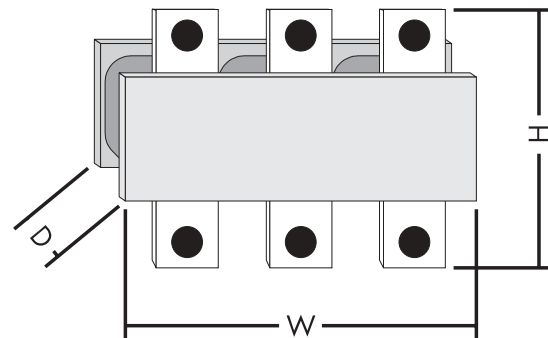

DC Accessories Three-Phase Line Reactors

These reactors are intended for use with the 590 Series three-phase controllers. They may be used when voltage transformation or supply isolation is not required. Line reactors:

- Reduce the level of voltage notching on the supply
- Limit total radiated RF interference
- Reduce current spikes in the supply lines during commutation of the SCR bridge.

Dimensions

Amps	Height (H)	Width (W)	Depth (D)	Weight
35	4.5 (114)	6.1 (155)	4.75 (121)	8 (3.6)
70	5.5 (140)	6.1 (155)	4.75 (121)	11 (5.0)
110	5.5 (140)	6.1 (155)	4.75 (121)	15 (6.8)
180	13.0 (330)	7.5 (191)	6.25 (159)	27 (12.3)
250	15.0 (380)	11.0 (280)	10.0 (255)	
360	15.0 (380)	11.0 (280)	10.0 (255)	
550	15.7 (398)	14.5 (366)	12.0 (306)	
720	15.7 (398)	14.5 (366)	12.0 (306)	

All dimensions are in inches (mm) and weights are in Lb. (Kg).

Three-Phase Line Reactors for EMC

These reactors are used with EMC filters (see page 26) for DC controllers that must meet CE standards.

Armature DC Contactor Option

For use with 590+ frames 1 and 2, this assembly provides a 3-pole DC loop contactor (includes dynamic braking contact) that isolates the motor from the drive. Dynamic Braking requires an additional braking resistor kit.

Note: Do not order with Dynamic Braking Contact Option, contact included in assembly.

COMPACT DESIGN

UL AND CSA APPROVALS THROUGH 110A

RATING FOR 230 AND 480 VAC SUPPLIES

TAB TERMINAL CONNECTIONS

Horsepower

230VAC	460VAC	DC Amps	Description	Catalog No.
10	20	35	Reactor 50 μ H (UL/CSA)	C0352378
20	40	70	Reactor 50 μ H (UL/CSA)	C0352379
30	60	110	Reactor 50 μ H (UL/CSA)	C0352380
50	100	180	Reactor 50 μ H	C0055255
60	150	250	Reactor 25 μ H	C0057960
100	200	360	Reactor 25 μ H	C0057961
150	300	550	Reactor 25 μ H	C0057962
200	400	720	Reactor 25 μ H	C0057963

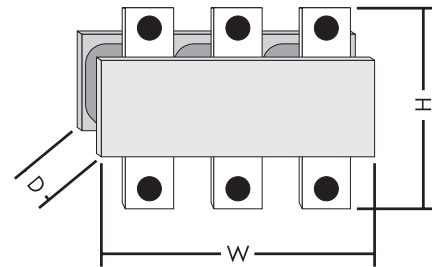

CE APPROVED

RATINGS TO 180A

Three-Phase Line Reactors

Size* DC Amps	Catalog No.
15	C0466449U015
40	C0466449U040
70	C0463037
110	C0463038
180	C0463039

*Above 180 Amps use the standard line reactors listed above

1 TO 100 HP

Horsepower

240VDC	500VDC	Catalog No.
1 - 7.5	1 - 15	955 + ADC30
10 - 15	20 - 30	955 + ADC60
20 - 40	40 - 75	955 + ADC130
50	100	955 + ADC220

COMPACT DESIGN

ROOF/PANEL MOUNTING

HORSEPOWER RATED FOR EASIER SELECTION

INTEGRAL COVERS FOR ADDED SAFETY

DC Accessories

Dynamic Braking Resistors

The Dynamic Braking Resistor kits are designed for stopping a motor at full load current from base speed with 2 times motor energy, three times in rapid succession (NEMA ICS 3-302.62 Dynamic Braking Stop Option).

Dynamic braking provides a low initial cost solution when motor braking can be less precise. When braking is required frequently in the application (for example, unwinds), a regenerative drive would be a better solution.

Dynamic Braking Contact

590+ DRV frames 1, 2 and 6+ require a separate dynamic braking contact kit if dynamic braking is required.

The kits through 100 Hp use a four-pole AC contactor pre-wired to connect to the 590+ terminals.

Above 100 Hp, kits use a single-pole DC contactor that requires 120 VAC control power to close. The dynamic braking contact must be factory installed and requires a larger panel.

The Dynamic Braking Contact Kits are designed to meet NEMA dynamic braking requirements (see Dynamic Braking Resistors above).

Note: When power is lost, the DB contactor will not close on Size 6 or larger drives.

ACCESSORIES

240 VDC DB Resistors

Hp	Ohms	Catalog No.
5	8.6	CZ353160*
7.5	6.04	CZ353161*
10	4.6	CZ353162*
15	3	CZ353163*
20	2	CZ353164*
25	2	CZ353165*
30	1.4	CZ353166*
40	1	CZ353167*
50	1	CZ353168*
60	0.742	CZ353169
75	0.58	CZ353170
100	0.452	CZ353171
125	0.384	CZ353172
150	0.325	CZ353173*
200	0.255	CZ353174*
250	0.196	CZ353175*
300	0.176	CZ353176*
400	0.137	CZ353177*
500	0.1	CZ353178*

500 VDC DB Resistors

Hp	Ohms	Catalog No.
3	62	CZ353134*
5	36	CZ353135*
7.5	36	CZ353136*
10	20	CZ353137*
15	12	CZ353138*
20	10	CZ353139*
25	7	CZ353140*
30	7	CZ353141*
40	4.5	CZ353142*
50	4.5	CZ353143*
60	4	CZ353144*
75	2.8	CZ353145*
100	2	CZ353146*
125	1.71	CZ353147
150	1.28	CZ353148
200	1.11	CZ353149
250	0.768	CZ353150
300	0.72	CZ353151*
400	0.504	CZ353152*
500	0.38	CZ353153*
600	0.38	CZ353154*
700	0.288	CZ353155*
800	0.23	CZ353156*
900	0.23	CZ353157*
1000	0.2	CZ353158*

Kits with an ** require an additional dynamic braking contact.

500 VDC RATED

MEET NEMA DYNAMIC BRAKING STANDARDS

Horsepower		
240VDC	500VDC	Catalog No.
1 - 10	1 - 20	955 + DBC35
15 - 20	30 - 40	955 + DBC70
25 - 30	50 - 60	955 + DBC110
0 - 50	75 - 100	955 + DBC162
150 - 700	300 - 1500	955-DBC2400*
800 - 1000	1750 - 2000	955-DBC3000*

* Factory installed option only.

DC Accessories

590+ DRV Control Transformer

The 590+ DRV Control Transformer option enables 590+ DRVs to be used in systems that do not use 120 VAC control power.

Blower Motor Starter

The 590+ DRV Blower Motor Starter Option uses a manual motor circuit controller to provide motor overload and branch circuit protection for a single- or three-phase AC blower motor. The option mounts inside 590+ DRV DC Drives through 100 HP.

Controller AC Line Fuse Kits

The AC line fuse kits provide SCR protection for the 590+ Series controllers. Fuse kits protect drives against transients that may occur in drive supply lines. Each fuse kit contains three high speed fuses with fuseblocks.

Note:

(a) The customer is responsible for complying with all local codes when installing these fuse kits. Eurotherm Drives will not accept any responsibility for mounting the fuse kits improperly.

(b) The kits do not include panel mounting hardware.

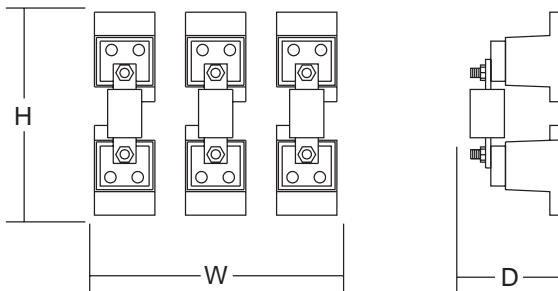

OPERATION WITH 208 THROUGH 500 VAC SUPPLIES
 MOUNTS INSIDE THE FRAME 1 AND 2 DRVS
 NOT NEEDED ON DRVS ABOVE 100 Hp (AT 500 VDC)

Add -CX suffix to the 590+ DRV part number

UL LISTING AND CSA CERTIFICATION

INSTANTANEOUS MAGNETIC SHORT-CIRCUIT PROTECTION

THERMAL OVERLOAD PROTECTION WITH ADJUSTABLE TRIP CURRENT SETTING

START/STOP-RESET SWITCHING WITH "TRIPPED"

PUSHBUTTON INDICATION

NORMALLY-OPEN AUXILIARY CONTACT WIRED TO TERMINAL

Ordering Information

AMPS	Catalog No.	
	Frame 1 & 2	All Other
0.10-0.16	955 + BMS016	955-BMS160
0.16-0.25	955 + BMS025	955-BMS250
0.25-0.40	955 + BMS040	955-BMS400
0.40-0.63	955 + BMS063	955-BMS630
0.63-1.00	955 + BMS100	955-BMS110
1.00-1.60	955 + BMS160	955-BMS161
1.60-2.50	955 + BMS250	955-BMS251
2.50-4.00	955 + BMS400	955-BMS410
4.00-6.30	955 + BMS630	955-BMS631

ALL UL LISTED OR RECOGNIZED COMPONENTS

CSA CERTIFIED

300 TO 800 AMPERES

500 VAC

COMPRESSION TERMINAL FOR CONNECTIONS

Horsepower

230VAC	460VAC	Amps	Catalog No.
75	150	300	655-FK33
100	200	400	655-FK43
125	250	500	655-FK53
150	300	600	655-FK63*
200	400	800	655-FK83*

*Require ring terminals for connection.

Dimensions

Fuse Kit	Height (H)	Width (W)*	Depth (D)
655-FK33, -FK353, -FK43	8.75 (222)	8.56 (217)	4.44 (113)
655-FK63, -FK83	7.5 (191)	9.00 (229)	3.44 (87)

* Widths include minimal space for electrical clearance to equipment mounted next to the fuse kits

SUITABLE FOR MOTOR VOLTAGES 100 - 550V

IR COMPENSATION UP TO 11%

DIN RAIL MOUNTING

BI-DIRECTIONAL OPERATION

TRIM OUTPUT POTENTIOMETER

DC Accessories

Armature Voltage Feedback Unit 5590

This unit provides a means of isolating and attenuating motor armature voltage to levels compatible with drive input signals to give cost effective voltage feedback. It is designed specifically for use with analog drives.

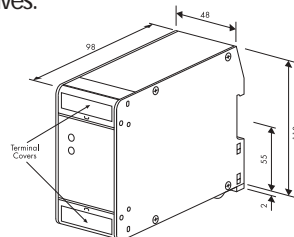

Ordering Information

Description	Catalog No.
Armature voltage feedback unit	5590

3 DIGIT LCD READOUT

ACCESS TO 27 TEST POINTS

OSCILLOSCOPE/RECORDER OUTPUT

Diagnostic Unit 5570

An easy to use hand held diagnostic unit. The 5570 can be used in conjunction with the 514C and 5401 field controller. It gives access to 27 key test points on the drives, rapidly decreasing commissioning time and simplifying trouble shooting.

Ordering Information

Description	Catalog No.
Diagnostic unit	5570

RATING FOR 230 AND 480 VAC SUPPLIES

1/4 INCH TAB TERMINAL CONNECTIONS

PANEL MOUNTED

Three-Phase Line Filter

The filter provides additional protection against spikes induced on the AC line by DC controllers on 460 VAC systems. It is recommended when accessories (such as blower motors) are connected to the same main supply as the controller without isolation.

The completely wired fuse kit contains fuses and fuseblocks to provides branch circuit protection for the line filter.

Ordering Information

Description	Catalog No.
Three-phase line filter	LA048357
Fuse kit for three-phase line filter	LA353827

Note: A line filter is included in all 590+ DRVs above 100 horsepower (at 500 VDC)

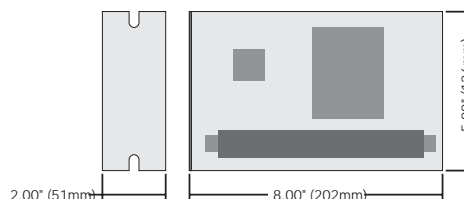

EMC Filters

A range of custom designed optional EMC (ElectroMagnetic Compatibility) filters are available for use with the Eurotherm Drives product range. These have been carefully designed to provide cost effective and easily implemented solutions for a variety of standard installations.

AC and DC Drive Filters Technical Specifications

Product Number	Rating	Filter Part Number	Filter Style Mounting Kit	IP40 Wall	Emission Standard	Max. Cable Length
AC Drive Filters						
650/ 650V (200v)	Frame 1, 2,& 3	Order with Drive	INT	–	B	25m*
650/650V (400v)	Frame 1, 2,& 3	Order with Drive	INT	–	A	25m*
605/690+	Frame A & B	Order with Drive	INT	–	B	25m*
Filters for ONLY Grounded Neutral (TN) AC supplies up to 460V						
650V/690+	Frame C	CO465513U036	FP	BA465514U036	B	50m
650V/690+	Frame D	CO465513U070	FP	BA465514U070	B	50m
650V/690+	Frame E	CO465513U105	FP	BA465514U105	B	50m
650V/690+	Frame F	CO465513U215	FP	–	B	50m
Filters for Grounded Neutral (TN) or Ungrounded (IT) AC supplies up to 480V						
650V/690+	Frame C	CO465515U036	FP	BA465514U036	A	50m
650V/690+	Frame D	CO465515U070	FP	BA465514U070	A	50m
650V/690+	Frame E	CO465515U105	FP	BA465514U105	A	50m
650V/690+	Frame F	CO465515U215	FP	–	A	50m
690+	Frame G	CO464517	MOD	–	A	300m
690+	Frame H	CO464517 (2X)	MOD	–	A	300m
690+	Frame J	CO464517 (2X)	MOD	–	A	300m
DC Drive Filters						
506/507/508	3,6,12A	CO389115	FP	-	B	50m
512C/ 514C	4,8,16A	CO389113	FP	-	B	50m
512C/ 514C	32A	CO389114	FP	-	B	50m
590+ /955+	15A	CO466516U015	MOD	-	A	50m
590+ /955+	35,40A	CO466516U040	MOD	-	A	50m
590+ /955+	70A	CO466534U070	MOD	-	A	50m
590+ /955+	110A	CO466534U110	MOD	-	A	50m
590+ /955+	165A	CO466534U165	MOD	-	A	50m
590+ /955+	180A	CO388965U180	MOD	-	A	50m
590+ /955+	270, 360A	CO389456	MOD	-	A	50m
590+ /955+	450A	CO389456 (2X)	MOD	-	A	50m
590+ /955+	720, 800A	CO389456 (3X)	MOD	-	A	50m

* External filters available for cable runs longer than those specified

Please refer to you local Eurotherm Drives sales office for details of EMC filters > 800A

The 590+ filters must be used in conjunction with the appropriate 2% impedance ac line choke (see page 22)

INT = Internal Filter, factory installed within the drive module.

FP = Space saving Footprint Filter that fits behind the drive.

MOD = Module filter that must be mounted adjacent to the drive.

Emission Standard A = EN55011 Class A (Industrial EMC environment of EN50081-2)

Emission Standard B = EN55011 Class B (Residential, commercial and light industrial EMC environment of EN50081-1)

SIMPLE INSTALLATION

TRANSMIT 196 FEET (60 METERS)

ELECTRICALLY NOISE IMMUNE

Ordering Information

Description	Catalog No.
Composite fiber optic cable 165 ft (50m) acrylic	CM059748U050
Composite fiber optic cable 660 ft (200m) acrylic	CM059748U200
Composite fiber optic cable 1650 ft (500m) acrylic	CM059748U500

Description	Catalog No.
Duplex fiber optic cable 99 ft (30m) acrylic	CM352278U030
Duplex fiber optic cable 495 ft (150m) acrylic	CM352278U152
Duplex fiber optic cable 990 ft (300m) acrylic	CM352278U305

Description	Catalog No.
Single fiber optic cable 99 ft (30m) acrylic	CM056316U030
Single fiber optic cable 495 ft (150m) acrylic	CM056316U152
Single fiber optic cable 1000 ft (305m) acrylic	CM056316U305

Ordering Information

Description	Catalog No.
Black fiber optic connector	C1055070
Red fiber optic connector	C1055069
Cutter kit f/acrylic fiber optic cable	LA385204

UL APPROVED OPTIC FIBER CABLE-RISER

5000 FEET TRANSMISSION DISTANCE

MHZ-KM BANDWIDTH

Ordering Information

Description	Catalog No.
Cable assembly 82 ft (25m)	CM352692U251
Cable assembly 165 ft (50m)	CM352692U501
Cable assembly 247 ft (75m)	CM352692U751
Cable assembly 330 ft (100m)	CM352692U102
Cable assembly 495 ft (150m)	CM352692U152
Cable assembly 660 ft (200m)	CM352692U202
Cable assembly 825 ft (250m)	CM352692U252
Cable assembly 990 ft (300m)	CM352692U302
Cable assembly 1320 ft (400m)	CM352692U402
Cable assembly 1650 ft (500m)	CM352692U502
Cable assembly 3300 ft (1000m)	CM352692U103
Glass Termination Kit	JA352597
Glass ST Connector	CI352599
Cable Anchor (spares for assembling CI351599)	CI352673
Crimp Sleeve (spares for assembling CI351599)	CI352674

Fiber Optic Accessories

Plastic Fiber Optic Cable

Eurotherm Drives flexible acrylic fiber optic cable has a minimum bending radius of 1.5 inches. Terminations are made simply by snapping together the two parts of the plastic fiber optic connectors with a pair of pliers (no special tools are required). The connectors are color-coded: Transmit - red; Receive - black.

Composite Fiber Optic Cable

Composite fiber optic cable combines a single strand of acrylic fiber optic cable and two copper wire cables. It is used in applications where repeater modules are needed. The composite cable carries the fiber optic signal and a 24V supply to the repeater module.

Duplex Fiber Optic Cable

Duplex fiber optic cable consists of two parallel strands of acrylic cable bonded together. It is often used when remote modules are installed in a system; for example, in an operator station.

Single Strand Fiber Optic Cable

Single strand acrylic fiber optic cable is used inside drive enclosures.

Glass Fiber Optic Cable

These components are used with the acrylic fiber optic cable.

The flexible glass fiber optic cable ships with one standard ST style connector installed. Glass fiber optic cable is used for sending data over long distances. Glass cable is recommended in cases where distances exceed 328 feet (100 meters) or installed through high temperature areas.

Ordering Information

Order one connector with each cable assembly. Additional cable anchors (CI352673) and crimp sleeves (CI352674) are often required when assembling ST connectors.

Note: Glass Termination Kit (JA352597) is needed to assemble the connectors for the glass fiber optic cable.

General Accessories Signal Isolators

These isolators are DIN rail mounted devices that provide electrical isolation between its input and output circuitry.

Input can be from 10mV to 100V or 1mA to 100mA. Output can either be voltage (0-5V, 0-10V, $\pm 5V$ or $\pm 10V$) or current (0-1mA, 0-20mA, or 4-20mA).

5530 Loadcell Amplifier

The 5530 loadcell amplifier scales the high level output signal from a strain gauge or LVDT loadcells for use as tension indication or as a feedback signal for material tension control. The force created by tension in the web is converted into a DC voltage that is proportional to web tension and the supply voltage.

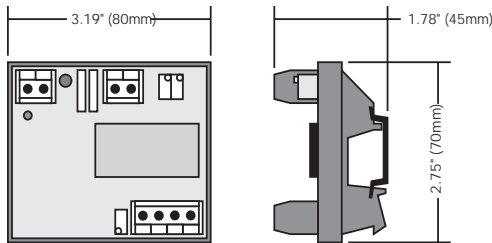

Non-Contact Dancer Position Potentiometer

This potentiometer provides 0-10 volt dancer position feedback. It is designed to be mounted on the machine to provide material take-up control. The design eliminates dead spots common after extended usage.

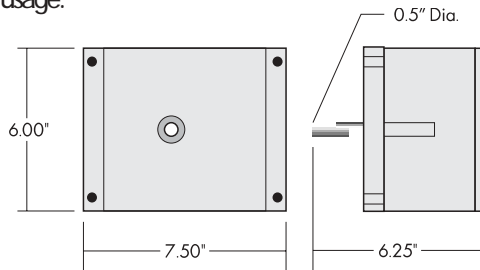

L5231 Fiber Optic Light Meter

The L5231 measures light levels in both plastic and glass fiber optic cable. This meter is invaluable during start-up to ensure trouble-free communications

PROVIDES A FULLY ISOLATED DC OUTPUT IN PROPORTION TO A DC INPUT

EASY FIELD CONFIGURABLE INPUT AND OUTPUT RANGES

ULTRA SLIM 12.6MM (0.5") HOUSING MOUNTS ON DIN RAIL FOR HIGH DENSITY INSTALLATION

Ordering Information

Description	Catalog No.
Universal Input/Voltage output	LA470509
Universal Input/Current output	LA470554

-10 TO +10 VDC OUTPUT

OFFSET AND SPAN FOR CALIBRATION

EXCITE POTENTIOMETER FOR SCALING THE LOADCELL SUPPLY VOLTAGE

ADJUSTABLE BANDWIDTH AND FILTER

DIN RAIL MOUNTABLE AND WIRED TO CUSTOMER TERMINALS

Ordering Information

Description	Catalog No.
Amplifier for LVDT load cell	5530/1
Amplifier for strain gauge load cell	5530/2

NEMA 4 CONSTRUCTION

300 DEGREE TRAVEL

HEAVY DUTY TERMINALS

Ordering Information

Description	Catalog No.
Dancer position non-contact potentiometer	DD353481
Dancer position non-contact potentiometer with limit switches	DD353482

STURDY, HAND-HELD DESIGN

CONTAINS PLASTIC AND GLASS CABLE ADAPTERS

Ordering Information

Description	Catalog No.
Light Meter	L5231
Light Meter Instructions	HW351772
T&B Adapter for Light Meter	JB470146
ST Adapter for Light Meter	JB352598

16-BIT REFERENCE SIGNAL

CONFIGURATION FOR MASTER/SLAVE OPERATION

FULLY CONFIGURABLE INPUT AND OUTPUT SIGNALS

ADDITIONAL FIBER OPTIC TRANSMITTER

DIN RAIL MOUNTABLE

Ordering Information	
Description	Catalog No.
RS-232 peer-to-peer comms	5703/1

STANDARD QUARTER DIN SQUARE CUTOUT

SINGLE QUADRANT AND CIRCULAR SCALE VERSIONS

Ordering Information	
Description	Catalog No.
Analog load meter (0 -150%)	5507/1/1/L1
Analog load meter (150-0-150%)-Center zero	5507/1/2/L2
Analog load meter (150-0-150%)-Circular scale	5507/1/3/L2
Analog speed meter (0-100%)	5507/1/1/S1
Analog tension meter (0-100%)	5507/1/1/T1
Quadrant Meter, uncalibrated	5507/1/1
Quadrant Meter with Center Zero, uncalibrated	5507/1/2
Circular scale Meter, uncalibrated	5507/1/3

DIGIT DISPLAY TO 1999 ±0.05% FS ACCURACY

3 POSITION DECIMAL POINT

±5V TO ±400V DC INPUT

RATIOMETRIC DISPLAY OF 2 ANALOG SIGNALS

LAST DIGIT FLICKER INHIBIT

90-130V OR 180-260V AC SUPPLY

CE MARKED TO EN61010 (1994)

Ordering Information	
Description	Catalog No.
5512 Digital Panel Meter	DA054339

General Accessories

5703 Peer-to-Peer Communications Module

The 5703 allows peer-to-peer communication between 590+ or 690+ controllers over a fiber optic cable. It can access any readable 590+ or 690+ Series controller parameter, including speed, current and feedback signals. It allows users to implement extremely accurate draw or ratio schemes. One 5703 is required per drive when digital master or follower capability is required.

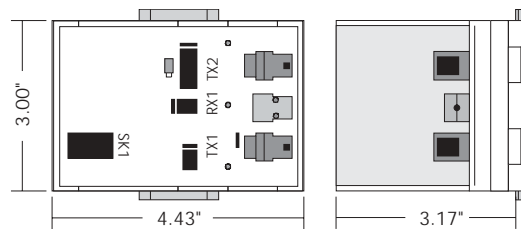

5507 Analog Panel Meters

5507 meters provide NEMA 1 protection when mounted in an enclosure. They connect directly to the analog outputs on drives for speed or load indication.

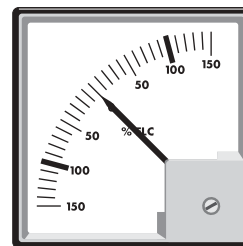

Digital Panel Meter Type 5512

The extremely versatile 5512 Digital panel meter is ideal for a wide range of signal display applications. Front access multi turn scaling, offset potentiometers and slide in custom legend guarantee minimum set up time.

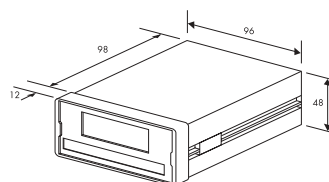

Accessories

DC Drive/Motor Packages 1 to 1000 Hp

TECHNICAL SPECIFICATION

See the 590+ section for drive specifications.

Ambient – 0-40°C (32-104°F)

Altitude – 1000m (3300 ft.) ASL

Insulation – Class F

Overload – 150 percent for 60 seconds

DC Drive/Motor packages include a matched 590+ DRV and DC motor. Optional C-face mounting and conduit box location selections assure the package meets your physical requirements. Speed feedback options let you meet any performance demand.

The high efficiency, shunt wound DC motor is especially designed for use with variable speed DC drives. These standard motors are fully guarded for safe operation. Forced ventilation assures reliable performance over the entire speed range. Just add a blower motor starter and your design is complete.

In addition, this package provides an additional discount over the price of separately ordered parts.



PREMIUM QUALITY AND VALUE

PERFORMANCE-MATCHED COMBINATION

SINGLE-SOURCE SHOPPING FOR YOUR CUSTOMER

BEST DC DRIVE MOTOR IN THE INDUSTRY

ADDITIONAL DISCOUNT ON MOTOR/DRIVE COMBINATION

COMPACT SQUARE FRAME DESIGN

500 VDC 1750 RPM Base Speed

HP	Part Number	Encl	Frame	Max RPM
1	955 + 8R0001M	DPFG-FV	C1811ATZ	2300
2*	955 + 8R0002M	DPFG-FV	C1811ATZ	2300
3*	955 + 8R0003M	DPFG-FV	C1811ATZ	2300
5*	955 + 8R0004M	DPFG-FV	C1811ATZ	2300
7.5*	955 + 8R0007M	DPFG-FV	C1811ATZ	2300
10*	955 + 8R0010M	DPFG-FV	C1811ATZ	2300
15*	955 + 8R0015M	DPFG-FV	SC2113ATZ	2300
20*	955 + 8R0020M	DPFG-FV	SC2113ATZ	2300
25*	955 + 8R0025M	DPFG-FV	MC2113ATZ	2300
30*	955 + 8R0030M	DPFG-FV	LC2113ATZ	2300
40*	955 + 8R0040M	DPFG-FV	MC2115ATZ	2100
50*	955 + 8R0050M	DPFG-FV	LC2115ATZ	2100
60*	955 + 8R0060M	DPFG-FV	LC2512ATZ	2100
75*	955 + 8R0075M	DPFG-FV	C2514ATZ	2100
100*	955 + 8R0100M	DPFG-FV	C2515ATZ	2100
125*	955 + 8R0125M	DPFG-FV	C2813ATZ	2100
150*	955 + 8R0150M	DPFG-FV	C2815ATZ	2100
200*	955 + 8R0200M	DPFG-FV	C3214ATZ	2100
250	955 + 8R0250M	DPFG-FV	LC3612ATZ	2100
300*	955 + 8R0300M	DPFG-FV	LC3612ATZ	2100
400*	955 + 8R0400M	DPFG-FV	MC4013ATZ	2100
500*	955 + 8R0500M	DPFG-FV	C4412ATZ	2050
600	955 + 8R0600M	DPFG-FV	B587ATZ	1900
700	955 + 8R0700M	DPFG-FV	BB587ATZ	1900
800	955 + 8R0800M	DPFG-FV	B685ATZ	1925

500 VDC 1150 RPM Base Speed

HP	Part Number	Encl	Frame	Max RPM
1	955 + 8R0001L	DPFG-FV	C1811ATZ	2000
2	955 + 8R0002L	DPFG-FV	C1811ATZ	2000
3	955 + 8R0003L	DPFG-FV	C1811ATZ	1900
5	955 + 8R0004L	DPFG-FV	C1811ATZ	1900
7.5	955 + 8R0007L	DPFG-FV	C1812ATZ	2300
10	955 + 8R0010L	DPFG-FV	SC2113ATZ	2300
15	955 + 8R0015L	DPFG-FV	MC2113ATZ	2100
20	955 + 8R0020L	DPFG-FV	LC2113ATZ	2000
25	955 + 8R0025L	DPFG-FV	LC2115ATZ	2000
30*	955 + 8R0030L	DPFG-FV	LC2115ATZ	2300
40*	955 + 8R0040L	DPFG-FV	L2512ATZ	2000
50*	955 + 8R0050L	DPFG-FV	C2514ATZ	2000
60*	955 + 8R0060L	DPFG-FV	C2515ATZ	2000
75*	955 + 8R0075L	DPFG-FV	C2815ATZ	2000
100*	955 + 8R0100L	DPFG-FV	C2815ATZ	1850
125*	955 + 8R0125L	DPFG-FV	C3214ATZ	2000
150*	955 + 8R0150L	DPFG-FV	LC3612ATZ	2000
200*	955 + 8R0200L	DPFG-FV	C37613ATZ	2000
250*	955 + 8R0250L	DPFG-FV	MC4013ATZ	2000
300*	955 + 8R0300L	DPFG-FV	LC4013ATZ	2000
400*	955 + 8R0400L	DPFG-FV	C4413ATZ	1600
500*	955 + 8R0500L	DPFG-FV	C4414ATZ	1680
600	955 + 8R0600L	DPFG-FV	B589ATZ	1650
700	955 + 8R0700L	DPFG-FV	BB5810ATZ	1500
800	955 + 8R0800L	DPFG-FV	B687ATZ	1350
900	955 + 8R0900L	DPFG-FV	B842AT	1350
1000	955 + 8R1000L	DPFG-FV	B842AT	1200

240 VDC 1750 RPM Base Speed

HP	Part Number	Encl	Frame	Max RPM
1	955 + 4R0001M	DPFG-FV	DC189ATZ	2300
2	955 + 4R0002M	DPFG-FV	DC189ATZ	2300
3*	955 + 4R0003M	DPFG-FV	DC189ATZ	2300
5*	955 + 4R0004M	DPFG-FV	C1811ATZ	2300
7.5*	955 + 4R0007M	DPFG-FV	C1811ATZ	2300
10*	955 + 4R0010M	DPFG-FV	C1812ATZ	2300
15*	955 + 4R0015M	DPFG-FV	SC2113ATZ	2300
20*	955 + 4R0020M	DPFG-FV	SC2113ATZ	2300
25*	955 + 4R0025M	DPFG-FV	MC2113ATZ	2300
30*	955 + 4R0030M	DPFG-FV	LC2113ATZ	2300
40*	955 + 4R0040M	DPFG-FV	LC2115ATZ	2300
50	955 + 4R0050M	DPFG-FV	MC2512ATZ	2300
60	955 + 4R0060M	DPFG-FV	LC2512ATZ	2000
75	955 + 4R0075M	DPFG-FV	MC2812ATZ	2000
100	955 + 4R0100M	DPFG-FV	LC2812ATZ	2000
125	955 + 4R0125M	DPFG-FV	LLC3212ATZ	2000

240 VDC 1150 RPM Base Speed

HP	Part Number	Encl	Frame	Max RPM
1	955 + 4R0001L	DPFG-FV	DC189ATZ	2000
2	955 + 4R0002L	DPFG-FV	DC189ATZ	2000
3	955 + 4R0003L	DPFG-FV	DC189ATZ	2000
5	955 + 4R0004L	DPFG-FV	C1811ATZ	2000
7.5	955 + 4R0007L	DPFG-FV	C1812ATZ	2000
10	955 + 4R0010L	DPFG-FV	SC2113ATZ	2000
15	955 + 4R0015L	DPFG-FV	MC2113ATZ	2000
20	955 + 4R0020L	DPFG-FV	LC2113ATZ	2000
25	955 + 4R0025L	DPFG-FV	LC2115ATZ	2000
30	955 + 4R0030L	DPFG-FV	LC2115ATZ	2000
40	955 + 4R0040L	DPFG-FV	LC2512ATZ	2000
50	955 + 4R0050L	DPFG-FV	C2514ATZ	2000
60	955 + 4R0060L	DPFG-FV	C2515ATZ	2000
75	955 + 4R0075L	DPFG-FV	C3813ATZ	2000
100	955 + 4R0100L	DPFG-FV	LLC3212ATZ	2000
125	955 + 4R0125L	DPFG-FV	LC3214ATZ	2000
150	955 + 4R0150L	DPFG-FV	LC3513ATZ	2000
200	955 + 4R0200L	DPFG-FV	C4011ATZ	2000

* Note: Packages normally available from stock.

Replace the 'R' with 'N' for non-regenerative drive.

MOTOR OPTIONS

Conduit Box Location Option - The default conduit box location is F1. This is included in the package part number. To specify an F2 location, add a '-2' suffix to the part number.

C-Face Option - To add a C-face bracket to the motor, add a '-C' suffix to the part number. (frames from DC180ATZ to C360ATZ only).

Feedback Option - This option includes the feedback device, interface card, coupling, adaptor and mounting. Select only one feedback option per package.

The **encoder** option is a 5 to 15 VDC, 1024 PPR encoder; add a -E1 suffix to the package part number.

The **tachometer** option is a 50 volts per 1000 RPM tachometer rated to 5000 RPM maximum; add a -DT suffix to the package part number.

Example—Choose 955 + 8R0050M-2C-E1 for a 50 Hp, 500 VDC Regenerative drive and 1750 RPM base speed motor with a F2 conduit box, C-FACE option, and a 1024 encoder and encoder feedback card.

Isolation Transformers

Drive isolation transformers are designed to operate with SCR controlled drives. They can withstand SCR duty cycles and isolate the power source from SCR noise. The inherent impedance the transformer provides benefits the SCR controller and limits the rate of rise of transient currents.

- UL listing
- Design to applicable NEMA, ANSI, and IEEE standards
- Dry-type, Class AA, ventilated NEMA 2 enclosure for indoor use
- Floor mounting (optional wall mounting brackets up to 51 kVA)
- 60 Hertz, three-phase design

Ordering Information

All transformer modifications must be specified at time of order. They are not field installable.

MODIFICATIONS

Eurotherm Drives offers several modifications to customize the isolation transformers to your application.

Ordering Information

See the transformer modifications section when $\pm 2.5\%$ taps, special voltages, or 50 Hertz are required.

Additional $\pm 2.5\%$ taps

$\pm 2.5\%$ taps are installed on the high-voltage winding to correct for high/low voltage supplies.

50 Hertz Option

The transformers listed are designed for only 60 Hertz supplies. Select this option when using a 50 Hertz supply.

230:230 Three-phase Isolation Transformers

Hp	kVA	Description	Catalog No.
5	7.5	Isolation transformer	202-4451
7.5	11	Isolation transformer	202-44751
10	14	Isolation transformer	202-4412
15	20	Isolation transformer	202-44152
20	27	Isolation transformer	202-4422
25	34	Isolation transformer	202-44252
30	40	Isolation transformer	202-4432
40	51	Isolation transformer	202-4442
50	63	Isolation transformer	202-4452
60	75	Isolation transformer	202-4462
75	93	Isolation transformer	202-44752
100	118	Isolation transformer	202-4413

460:230 Three-phase Isolation Transformers

Hp	kVA	Description	Catalog No.
5	7.5	Isolation transformer	202-8451
7.5	11	Isolation transformer	202-84751
10	14	Isolation transformer	202-8412
15	20	Isolation transformer	202-84152
20	27	Isolation transformer	202-8422
25	34	Isolation transformer	202-84252
30	40	Isolation transformer	202-8432
40	51	Isolation transformer	202-8442
50	63	Isolation transformer	202-8452
60	75	Isolation transformer	202-8462
75	93	Isolation transformer	202-84752
100	118	Isolation transformer	202-8413

230:460 Three-phase Isolation Transformers

Hp	kVA	Description	Catalog No.
5	7.5	Isolation transformer	202-4851
7.5	11	Isolation transformer	202-48751
10	14	Isolation transformer	202-4812
15	20	Isolation transformer	202-48152
20	27	Isolation transformer	202-4822
25	34	Isolation transformer	202-48252
30	40	Isolation transformer	202-4832
40	51	Isolation transformer	202-4842
50	63	Isolation transformer	202-4852
60	75	Isolation transformer	202-4862
75	93	Isolation transformer	202-48752
100	118	Isolation transformer	202-4813
125	145	Isolation transformer	202-481253
150	175	Isolation transformer	202-48153
200	220	Isolation transformer	202-4823
250	275	Isolation transformer	202-48253
300	330	Isolation transformer	202-4833
400	440	Isolation transformer	202-4843
500	550	Isolation transformer	202-4853
600	660	Isolation transformer	202-4863
700	750	Isolation transformer	202-4873
800	870	Isolation transformer	202-4883
900	1000	Isolation transformer	202-4893
1000	1100	Isolation transformer	202-4814

460:460 Three-phase Isolation Transformers

Hp	kVA	Description	Catalog No.
5	7.5	Isolation transformer	202-8851
7.5	11	Isolation transformer	202-88751
10	14	Isolation transformer	202-8812
15	20	Isolation transformer	202-88152
20	27	Isolation transformer	202-8822
25	34	Isolation transformer	202-88252
30	40	Isolation transformer	202-8832
40	51	Isolation transformer	202-8842
50	63	Isolation transformer	202-8852
60	75	Isolation transformer	202-8862
75	93	Isolation transformer	202-88752
100	118	Isolation transformer	202-8813
125	145	Isolation transformer	202-881253
150	175	Isolation transformer	202-88153
200	220	Isolation transformer	202-8823
250	275	Isolation transformer	202-88253
300	330	Isolation transformer	202-8833
400	440	Isolation transformer	202-8843
500	550	Isolation transformer	202-8853
600	660	Isolation transformer	202-8863
700	750	Isolation transformer	202-8873
800	870	Isolation transformer	202-8883
900	1000	Isolation transformer	202-8893
1000	1100	Isolation transformer	202-8814

Special Primary or Secondary Voltage

Select this option when you require special primary or secondary voltages for your applications.

Surface Mounted Thermal Switch

This option provides a normally-closed contact for sensing transformer coil over-temperature. One switch is mounted in each winding.

Isolation Transformers

Application Notes

Eurotherm Drives recommends grounding the neutral of the Y-side (secondary side of the transformer.) By grounding the neutral point, the phase voltage will remain equal from phase-to-phase and phase-to-ground. Having balanced voltage levels will further protect drive components.

Ensure that all loads (especially single-phase loads) on three-phase transformers are balanced. Each leg of the transformer can carry one third of the full transformer rating. Divide any single-phase loads equally among each leg.

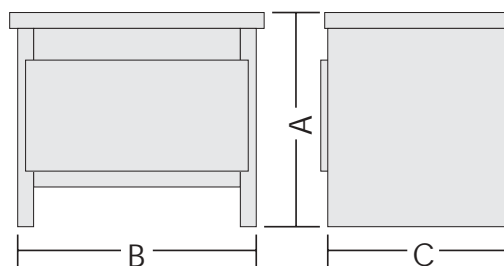
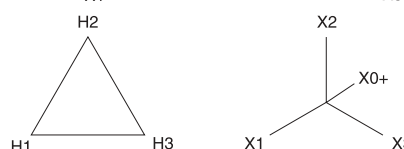
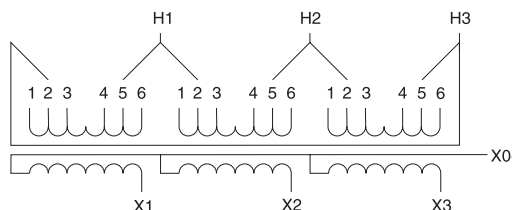

575:230 Three-phase Isolation Transformers

Hp	kVA	Description	Catalog No.
5	7.5	Isolation transformer	202-9451
7.5	11	Isolation transformer	202-94751
10	14	Isolation transformer	202-9412
15	20	Isolation transformer	202-94152
20	27	Isolation transformer	202-9422
25	34	Isolation transformer	202-94252
30	40	Isolation transformer	202-9432
40	51	Isolation transformer	202-9442
50	63	Isolation transformer	202-9452
60	75	Isolation transformer	202-9462
75	93	Isolation transformer	202-94752
100	118	Isolation transformer	202-9413

575:460 Three-phase Isolation Transformers

Hp	kVA	Description	Catalog No.
5	7.5	Isolation transformer	202-8851
7.5	11	Isolation transformer	202-88751
10	14	Isolation transformer	202-8812
15	20	Isolation transformer	202-88152
20	27	Isolation transformer	202-8822
25	34	Isolation transformer	202-88252
30	40	Isolation transformer	202-8832
40	51	Isolation transformer	202-8842
50	63	Isolation transformer	202-8852
60	75	Isolation transformer	202-8862
75	93	Isolation transformer	202-88752
100	118	Isolation transformer	202-8813
125	145	Isolation transformer	202-881253
150	175	Isolation transformer	202-88153
200	220	Isolation transformer	202-8823
250	275	Isolation transformer	202-88253
300	330	Isolation transformer	202-8833
400	440	Isolation transformer	202-8843
500	550	Isolation transformer	202-8853
600	660	Isolation transformer	202-8863
700	750	Isolation transformer	202-8873
800	870	Isolation transformer	202-8883
900	1000	Isolation transformer	202-8893
1000	1100	Isolation transformer	202-8814

Dimensions

kVA	Weight (lbs.)	A	B	C
7.5	145 (66)	29 (737)	17.13 (435)	19.38 (492)
11	165 (75)	29 (737)	17.13 (435)	19.38 (492)
15	185 (84)	29 (737)	17.13 (435)	19.38 (492)
20	285 (130)	34 (864)	22.38 (568)	19.88 (505)
27	315 (143)	34 (864)	22.38 (568)	19.88 (505)
34	320 (145)	34 (864)	22.38 (568)	19.88 (505)
40	345 (157)	34 (864)	22.38 (568)	19.88 (505)
51	400 (182)	34 (864)	22.38 (568)	19.88 (505)
63	480 (218)	34.5 (876)	27.88 (708)	14.25 (362)
75	495 (225)	34.5 (876)	27.88 (708)	14.25 (362)
93	600 (273)	40.5 (1029)	30.88 (784)	15.50 (394)
118	755 (343)	46 (1168)	34.38 (873)	16.50 (419)
145	810 (368)	46 (1168)	34.38 (873)	16.50 (419)
175	1030 (468)	50 (1270)	39.88 (1013)	19.75 (502)
220	1090 (495)	50 (1270)	39.88 (1013)	19.75 (502)
275	1450 (659)	55.25 (1403)	44.38 (1127)	27.25 (692)
330	1720 (782)	60.5 (1537)	50.38 (1280)	34.25 (870)
440	2085 (948)	60.5 (1537)	50.38 (1280)	34.25 (870)
550	2750 (1250)	72 (1829)	53.38 (1356)	44.38 (1127)
660	3100 (1409)	72 (1829)	53.38 (1356)	44.38 (1127)
750	3150 (1432)	72 (1829)	53.38 (1356)	44.38 (1127)

All dimensions are in inches (mm) and weights are in Lb.(Kg).

Software ConfigEd Lite

ConfigEd Lite is a software tool used to configure stand alone Eurotherm controllers. Using the same graphical user interface as DSD, you create and diagram your configurations in an easy-to-understand format that shows the functionality of your drive.

This off-line tool does not need drive hardware to create your configuration. Once complete simply install it into your drive. In addition, you can retrieve configurations from existing drives to get all settings and modify existing configurations.

ConfigEd Lite requires a Windows™ based computer with at least 4 MB of RAM, 2 MB of hard drive space, 3.5" floppy disk and one serial port for drive communication.

The package contains the complete ConfigEd Lite program with default configurations, product manual, and serial cable.

ConfigEd Lite DC Application Pack
The DC Applications Pack contains advanced configuration templates for control applications. The package includes configurations for current programmed winder, speed programmed winder, and section control.

Drive System Designer

Drive System Designer (DSD) is a power software tool used to configure Eurotherm LINK drive systems. DSD employs a graphical user interface and drawing tools that allow you to create and diagram your configurations in an easy-to-understand format that represents the functionality of your configuration.

Use basic function blocks to create an unlimited control schemes or use powerful built-in blocks simplify your system design. When troubleshooting the system, the on-line SAM tool speeds diagnostics with access to the entire system on the same graphical configuration template.

DSD requires a Windows™ based computer with at least 4 MB of RAM, 2 MB of hard drive space, 3.5" floppy disk and one serial port for drive communication.

Auto Configure Option
Auto Configure, the most revolutionary design package on the market, makes system design reach a new level of simplicity. In addition to DSD, the graphical interface automatically configures the system based upon real-world user input like section type (Unwind, Nip, etc.).

CREATE, INSTALL, MODIFY & RETRIEVE CONFIGURATIONS

GRAPHICAL INTERFACE

POWERFUL FUNCTION BLOCKS

DRAG AND DROP PROGRAMMING

WINDOWS™ BASED PLATFORM

Ordering Information

Description	Catalog No.
ConfigEd Lite new user	402-NU5
ConfigEd Lite 590 DC application package	402-DC5

Options

Description	Catalog No.
Serial cable, 25-pin to system port (3 feet)	CM351910
Serial adapter, 25-pin to 9-pin	LA350838

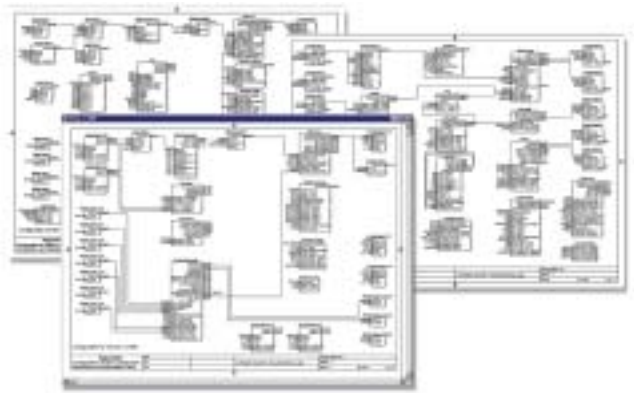

DESIGN OFF-LINE

TROUBLESHOOT ON-LINE

GRAPHICAL INTERFACE

DRAG AND DROP PROGRAMMING

WINDOWS™ BASED PLATFORM

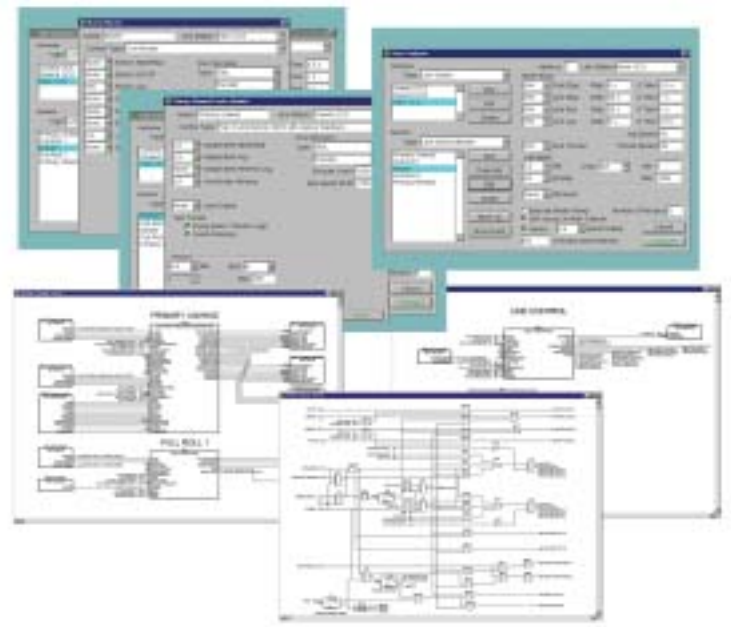

REAL-TIME MONITORING AND TUNING
 CREATE, INSTALL, MODIFY & RETRIEVE CONFIGURATIONS
 GRAPHICAL INTERFACE
 SCOPE FUNCTION
 DRAG AND DROP PROGRAMMING
 WINDOWS™ BASED PLATFORM

NEW Software

ConfigEd Lite Plus

ConfigEd Lite Plus is the next generation design and troubleshooting tool for standalone Eurotherm controllers. It includes the off-line configuration tool, ConfigEd Lite, PLUS an on-line tuning and troubleshooting package.

Compatible with our new 590+, 690+ and 650V models, users can start and stop the drive from their PC, set parameters, and monitor performance with the on-line scope. Startup is simplified further by built-in procedures that step the user through setup and tuning.

GRAPHICAL INTERFACE

With the graphical user interface, you create and diagram your configurations in an easy-to-understand format that shows the functionality of your drive. Default templates display all the drive function blocks and internal signal connections. Users can easily create new custom templates and reuse old designs.

OFF-LINE TOOL

This off-line tool does not need drive hardware to create your configuration. Once complete simply install it into your drive. In addition, you can retrieve configurations from existing drives to get all settings and modify existing configurations.

SYSTEM REQUIREMENTS

ConfigEd Lite Plus requires a Windows™based computer with at least 32 MB of RAM, 12 MB of hard drive space, CD-ROM and one serial port for drive communication.

The package contains the complete ConfigEd Lite Plus program with default configurations, product manual, and serial cable.

Ordering Information

Description	Catalog No.
ConfigEd Lite Plus new user	CEL + NU1

Options

Description	Catalog No.
Serial cable, 25-pin to system port (3 feet)	CM351910
Serial adapter, 25-pin to 9-pin	LA350838

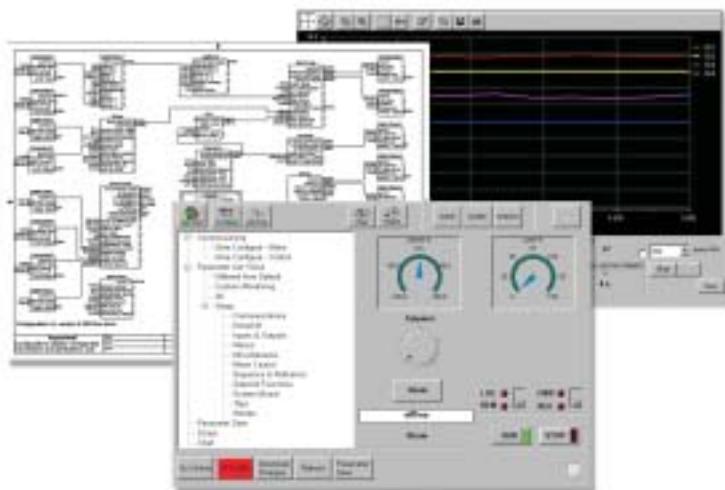

LINK – Fiber Optic Based Drive and Process Control System

LINK is an ultra high speed distributed drive control system. It enables all machine control elements including variable speed drives, operator controls and plant I/O to be networked together to provide integrated machine control of unrivalled flexibility.

Communication speeds of 2.7Mbaud allows LINK to operate a real time, event driven, deterministic network. Each control element of the machine or process is interconnected on a single, noise immune, fiber optic cable, which replaces the myriad of control wires traditionally associated with multi-drive systems. Typically savings of 50% in site cabling time and cost are possible with LINK compared to a standard wired system.

Each LINK system may comprise any combination of Eurotherm Drives sensorless and closed loop AC drives (690+, 605 and 620 series) or DC drives (590+ series). Digital and analog plant equipment can be interfaced onto the network via local or distributed I/O modules and a variety of gateway devices allow seamless integration with PC based control and monitoring packages.

The major component parts of a LINK control system are described below. There are however many other interface and peripheral components available that make LINK the world's most flexible control system, so please contact your nearest Eurotherm Drives sales outlet to discuss your application in detail.

TOTAL CONFIGURABILITY FOR THE MOST ADVANCED MULTI-DRIVE SYSTEMS

NOISE IMMUNE FIBER OPTIC BASED HIGHWAY

REAL TIME PEER TO PEER COMMUNICATIONS

FIELDBUS COMPATIBILITY

MODEM REMOTE ACCESS CAPABILITY

AC AND DC NETWORKED DRIVES

L5300 LinkRack

This high speed intelligent controller forms the heart of a LINK system. There are 4 slots that accommodate any of the plug-in modules below in addition to the main processor and power supply (single phase 85-265Vac). The L5300 has been designed for DIN Rail or direct panel mounting.

L5392 LinkStation

The L5392 is a touch-sensitive, color LCD operator station with provision (in the rear of the unit) for 4 option module slots. The multi-page operator screens are software configurable into 6 bands each grouping any combination of the following.

- Operator pushbuttons, each independently configurable
- Potentiometers, displaying and setting setpoint and feedback variables
- Indicators, displaying variables only
- Machine status and alarm indicators

L5331 Digital I/O LinkCard

16 x 24V channel digital input/output module. Each channel can be independently configured as an input or output. All terminals are plug-in and easily accessed on the front of the module and have LED indication of the "ON" state. A high speed counter for encoder or other pulse inputs is available.

L5341 Analog I/O LinkCard

8 x Input and 2 x Output analog module. Each channel is bipolar with 14 bit (13 bit + sign) resolution. +10V and -10V power supply outputs are provided for use with external devices including potentiometers and transducers. All terminals are disconnectable plug-in types.

L5311 RTN Fiber Optic LinkCard

Provides input and output connections for the acrylic fiber optic link.

L5202 Remote Digital I/O Module



L5201 Remote Analog I/O Module



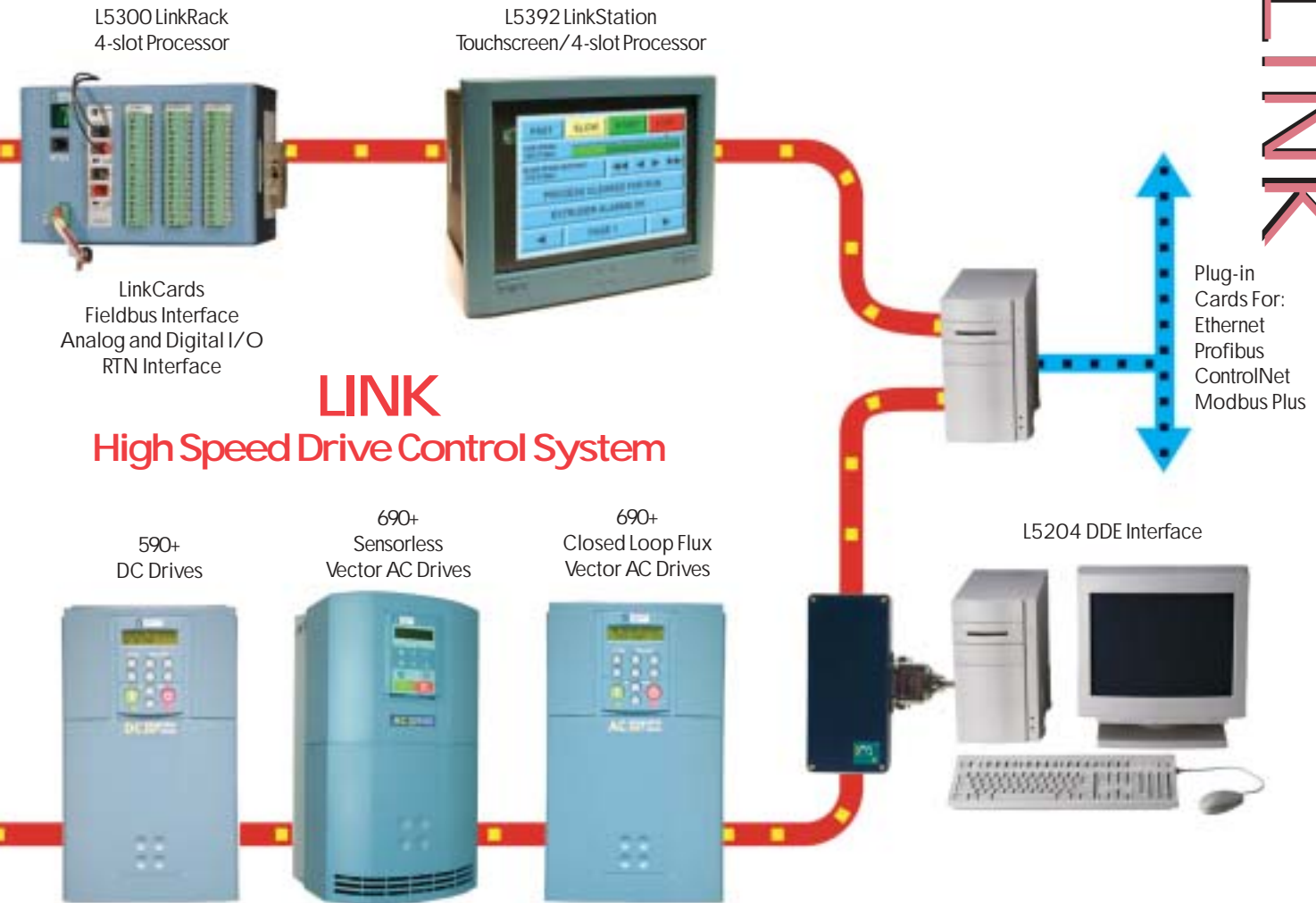

LINK High Speed Drive Control System

L5351 Devicenet LinkCard

Enables LINK to be interfaced into a Devicenet based system.

L5353 Profibus LinkCard

Enables LINK to be interfaced into a Profibus based system.

L5321 Serial Link/Modbus LinkCard

Enables LINK to be interfaced to Modbus or other serial protocol systems.

L5201 Remote Analog I/O Unit

Remote module providing 5 x analog inputs and 1 x analog output plus fiber optic interface. Particularly useful for distributed control around the machine or process.

L5202 Remote Digital I/O Unit

Remote module providing 12 x independently configurable 24V digital inputs or outputs plus fiber optic interface. Particularly useful for distributed control around the machine or process.

L5204 DDE Interface

DDE Interface module that opens the LINK network to any Windows based application including SCADA packages.

L5510 Universal Gateway

Universal gateway to additional Bus standards including Data Highway, Ethernet and VME.

DRIVE SYSTEM DESIGNER - Revolutionary System Design Software

Drive System Designer ("DSD") is like no other drive software. With the Auto Configure option, it actually designs the drive control system for you! You simply enter basic data on your process (line speed, web tension etc) and identify the function of each drive (unwind, nip roll etc) and DSD does the rest by selecting and configuring all the LINK hardware and software. Full details on this unique software package are on page 34.

631 1 to 6A

The 631 is much more than a basic Brushless Servo drive. With torque, speed, position or motion control, built-in I/O, EMC compliant filter and PLC functionality, it's a complete positioning system in a single module. The 631 can be connected directly to a 230 VAC single-phase supply without needing an isolation transformer.



Motion Controller

1500 Program steps
Real-time and multi-tasking structure: PLC, Math and Motion programs
Electronic gearing and CAM functions
CANopen comm ports: DS301 implemented

INPUTS/OUTPUTS

Analog Inputs - 1 ; (10 VDC)
Digital Inputs - 4; ENABLE and 3 User configurable (24 VDC)
Digital Outputs - 2; User configurable (24 VDC Sourcing)
Resolver Feedback - 12- or 14-bit, User selectable
Incremental I/O User Configurable
Encoder Input, step/dir, step/step or Simulated Encoder Output

CANBUS ANCILLARY EQUIPMENT

8 Channel I/O Expansion module (LA469119)
8 - Configurable digital inputs/outputs (max. 4 outputs)

DIRECT 230 VAC SUPPLY CONNECTION

INTEGRAL EMC COMPLIANT FILTERS

35MM DIN OR DIRECT PANEL MOUNT

635 / 637+ 2 to 30A

Torque, speed, position or motion control and built-in I/O are all standard features of the 635/637+ series Brushless Servo drive. Each model has an internal power supply allowing direct connection to the supply. 635 models are 230 VAC rated and 637+ models are rated for either 230 or 460 VAC supplies. They become part of a total servo package including motors, servo gearboxes and interconnecting cables.

The 635/637+ is available as a stand-alone drive or as a rack mounted module with up to 9 drives in a single rack.



Motion Controller

1500 Program steps
Real-time and multi-tasking structure: PLC, Math and Motion programs
Electronic gearing and CAM functions
Several Fieldbus options available

INPUTS/OUTPUTS

Analog Inputs (635) - 2; one 10-bit, one 12-bit (10 VDC)
Analog Inputs (637+) - 2; one 10-bit, one 14-bit (10 VDC)
Analog Outputs (635) - 2 ; 7-bit (10 VDC)
Analog Outputs (637+) - 2; one 8-bit, one 10-bit (10 VDC)
Digital Inputs - 8; ENABLE and 7 user configurable (24 VDC), (inc. 2 interrupts)
Digital Outputs - 5; OK and 4 user configurable (24 VDC Sourcing)
Resolver Feedback - 12- or 14-bit, User selectable (635) or 16-bit (637+)
Incremental I/O User Configurable
Encoder Input, step/dir, step/step or Simulated Encoder Output

DIRECT 230 OR 460 VAC SUPPLY CONNECTION

637+ RACK OPTION SUPPORTS 9 DRIVES

7-SEGMENT DIAGNOSTIC DISPLAY

MOTOR PROTECTION, I²T AND PTC/NTC

SIMPLE COMMISSIONING AND PROGRAMMING
VIA EASYRIDER[®] SOFTWARE

COMPLETE PACKAGE OF MOTORS, SERVO
GEARBOXES AND INTERCONNECTING CABLES



TECHNICAL SPECIFICATION

Power Supply - Single- or three-phase 220-240 VAC ($\pm 10\%$); 50 - 60 Hz $\pm 5\%$

Three-phase 380-460 VAC ($\pm 10\%$); 50 - 60 Hz $\pm 5\%$

Ambient - 0-40°C (32-104°F); derate 2% per °C to 50°C (122°F) maximum

Altitude - 1000m (3280 ft) ASL, derate 1% per 100m (330 ft) up to 4000m (13123 ft) maximum



631/635/637

1 to 30A

SERVO DRIVES

220-240V

Type	Amps Cont. (rms)	Amps Peak* (rms)	Cont. Output (kW)	Mech. Typ. (kW)	H (inch)	W (inch)	D** (inch)	Weight
631 SERIES Single-phase								
631/001/230/F/00	1	2	0.4	0.19	7.2	2.8	6.8	3.3 lb. (1.5 kg)
631/002/230/F/00	2	4	0.8	0.38				
631/004/230/F/00	4	8	1.5	0.76				
631/006/230/F/00	6	12	2.3	1.14				
635 SERIES Single/Three-phase								
635/KDER03-0	2.5	5	0.9	0.47	9.8	3.5	8.5	6
635/KDER05-0	5.0	10	1.9	0.95		3.5		6
635/KDER07-0	6.5	13	2.5	1.23		4.1		6.4
635/KDER10-0***	10.0	20	3.8	1.90		4.1		7.6
637+ SERIES Single/Three-phase								
637+/KD6R02-3	2	4	0.8	0.4	15.7	2.4	11	11
637+/KD6R04-3	4	8	1.5	0.8				
637+/KD6R06-3	6	12	2.3	1.1				
637+/KD6R10-3***	10	20	3.8	1.9				
637+/KD6R16-3***	16	32	6.1	3.0		4		19.4
637+/KD6R22-3***	22	44	8.4	4.2				
637+/KD6R30-3***	30	60	11.4	5.7				

Mounting holes 0.2" - use M5 screws

* Peak amps for 5 seconds

** 2.75" must be allowed for connectors/cables

*** Three phase only

380-460V ($\pm 10\%$) THREE-PHASE

Type	Amps Cont. (rms)	Amps Peak* (rms)	Cont. Output (kW)	Mech. Typ. (kW)	H (inch)	W (inch)	D** (inch)	Weight (lbs)
637+/KD6R02-7	2	4	1.6	0.8	15.7	2.4	11	11
637+/KD6R04-7	4	8	3.2	1.6				
637+/KD6R06-7	6	12	4.7	2.4				
637+/KD6R10-7	10	20	7.9	4.0				
637+/KD6R16-7	16	32	12.6	6.3		4		19.4
637+/KD6R22-7	22	44	17.4	8.7				
637+/KD6R30-7	30	60	23.7	11.8				

* Peak amps for 5 seconds

** 2.75" must be allowed for connectors/cables.

635/637+ FACTORY INSTALLED OPTIONS

Profibus-DP	Add suffix - PDP
CANbus	Add suffix - CAN
DeviceNet	Add suffix - DEV
SUCOnet K	Add suffix - SUC
RS232	Add suffix - 232
RS485	Add suffix - 485
RS422	Add suffix - 422
Interbus S	Add suffix - IBS
I/O Expansion Boards (only one per drive)	
635/Expansion board 5 Inputs / 2 Outputs	Add suffix - EA5
637+ Expansion board 14 Inputs / 10 Output	Add suffix - EAE

Example: 637+/KD6R16-3-PDP

EASYSRIDER® SOFTWARE

Easyrider software is a Windows based graphical programming utility for configuring the 63x series of Servo controllers. It provides a simple user interface for accessing all drive parameters, programming motion and calibrating the drive.

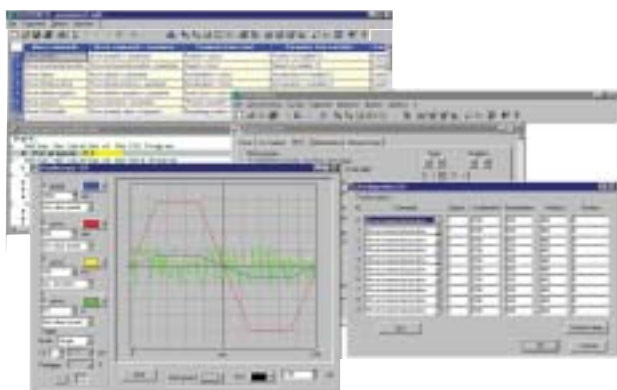

Complete cable assemblies between Parvex motors and 630 series drives.

COMPLETE CABLE ASSEMBLIES

Description	Part Number
Cable POWER, xxM with motor connector, 4 amp max.	220139R49xx
Cable POWER, xxM with motor connector, 8 amp max.	220139R42xx
Cable POWER, xxM with motor connector, 16 amp max.	220139R43xx
Cable POWER, xxM with motor connector, 32 amp max.	220139R48xx
Cable RESOLVER, xxM with motor connector	220049R51xx
Cable RESOLVER, xxM with motor and X30 connectors	220139R61xx

Note: Motor Power cables include brake and thermal conductors

xx = Cable length in meters; Standard lengths 2, 5, 10m. (6.5, 16.4, 32.8 ft)

Example: 220139R6150=50 meter (164 ft) long RESOLVER cable with motor & X30 connectors

LOOSE CABLES (NO CONNECTORS)

Description	Part Number
Power Cable, 0,5mm ² (20 AWG) (4 amp max.)	6537P0019
Power Cable, 1,0mm ² (18 AWG) (8 amp max.)	6537P0009
Power Cable, 2,5mm ² (14 AWG) (32 amp max.)	6537P0010
Resolver Cable, 3P, 0.34mm ²	6537P0001
CAN Cable, 2P, 0.14mm ²	KA.0003.8003
Signal Cable, 4P, 0.14mm ²	KA.0003.8015

LOOSE CONNECTORS

Description	Part Number
Motor POWER CONNECTOR size 1 (8 amp max.)	220065R1610
Motor POWER CONNECTOR size 1 (16 amp max.)	220065R1611
Motor POWER CONNECTOR size 3 (32 amp max.)	220065R3611
Motor RESOLVER CONNECTOR for Parvex motor	220065R4621
<i>Drive Connectors for 635/637+</i>	
X10 I/O	ST.1002.2003
X30/COM2	ST.1002.2001
X40	ST.1001.2002
X200	ST.1010.2001
COM1 for 635/637 only	ST.9701.0001
COM2 for Profibus	ST.0930.1701
Package X10,X30,X40 and COM 2	LA467063

CANbus ANCILLARY EQUIPMENT

Description	Part Number
8 Channel I/O CANbus Expansion Module	E/A-CAN
BCD Switch Module - 5 Digit plus sign with 6 digit LED readout	BCD-LED6-CAN-VZ000
CANbus terminator plug, 631 only X20/X21	CM469030
631 X20 (or X40) to 631 X20 (or X40) 100mm cable, 4C with connectors both ends	CM469036U001
631 X20 1m cable, 4C with connector one end	CM469029U010
631 X40 1m cable, 8C with connector one end	CM469033U010

CANbus HMI (HUMAN MACHINE INTERFACE)

Description	Part Number
4 x 20 Character IBT HMI	BE.1000.1805
IBT to 635/637+ (COM2), 2M Cable with Connectors	KK.5100.1301
Programming Cable, IBT to PC, 2M	KK.5100.1401
HMI Programming Software (Windows)	SO.9000.0005

SOFTWARE & PROGRAMMING CABLES

Description	Part Number
Programming Cable, PC-DRIVE 631/637+	CM351909
Programming Cable, PC-DRIVE 635/637	KK.5004.0001
EASYSRIDER Software on CD-ROM includes hardware and software manuals.	EASYSRIDER

For optional components; EMC/RFI filters, regenerative components, etc., please contact your local sales channel.

LX/NX BRUSHLESS SERVO MOTORS - for use with 220-240 VAC Drives

Motor Type	Static Torque	Static Torque	Cont. Current	Max. Speed	Inertia	Inertia
	Nm	lb-in	A rms	RPM	kgm ² x 10 ⁻⁵	lb-in-s ² x 10 ⁻⁴
NX110EEP	0.38	3.4	0.9	6000	1.2	1.1
NX210EET	1	8.9	0.9	4000	3.9	3.4
NX210EEP	1	8.9	2.0	6000	3.9	3.4
NX310EAP	2	17.7	1.4	2300	7.9	7.0
NX310EAK	2	17.7	2.5	4000	7.9	7.0
NX420EAP	4	35.4	2.8	2300	29	26
NX420EAJ	4	35.4	4.9	4000	29	26
NX430EAJ	5.5	48.7	5.2	3200	43	38
NX430EAF	5.5	48.7	6.6	4000	43	38
NX620EAR	8	70.8	5.3	2200	98	87
NX620EAJ	8	70.8	9.8	4000	98	87
NX630EAK	12	106.2	10.6	2800	147	130
NX630EAG	12	106.2	14.9	4000	147	130
LX820DH	19	168.2	19.5	2800	230	204
LX820DF	19	168.2	26.0	3800	230	204
LX840DG	38	336.3	20.9	1600	420	372
LX840DE	38	336.3	29.3	2200	420	372
*LX820VK	28	247.8	21.1	2000	230	204
*LX820VF	28	247.8	38.6	3800	230	204
*LX840VE	54	477.9	42.2	2200	420	372

* = Force air cooled motor

HX/NX BRUSHLESS SERVO MOTORS - for use with up to 480 VAC Drives

Motor Type	Static Torque	Static Torque	Cont. Current	Max. Speed	Inertia	Inertia
	Nm	lb-in	A rms	RPM	kgm ² x10 ⁻⁵	lb-in-s ² x10 ⁻⁴
NX310EAP	2	17.7	1.4	4600	7.90	6.99
NX420EAV	4	35.4	1.4	2300	29.0	25.7
NX420EAP	4	35.4	2.8	4600	29.0	25.7
NX430EAP	5.5	48.7	2.8	3450	42.6	37.7
NX430EAL	5.5	48.7	3.8	4600	42.6	37.7
NX620EAV	8	70.8	2.8	2300	98.0	86.7
NX620EAR	8	70.8	5.3	4490	98.0	86.7
NX630EAR	12	106.2	5.6	3110	147	130
NX630EAN	12	106.2	8.5	4600	147	130
HX820DT	19	168.2	5.6	1730	230	204
HX820DN	19	168.2	11.2	3570	230	204
HX820DJ	19	168.2	15.6	4200	230	204
HX840DN	38	336.3	10.5	1730	420	372
HX840DH	38	336.3	18.3	2600	420	372
*HX820VK	28	247.8	21.1	4600	230	204
*HX820VH	28	247.8	29.0	5000	230	204
*HX840VJ	55	486.8	21.6	2420	420	372
*HX840VG	55	486.8	30.8	3570	420	372
*HX840VG	55	486.8	30.8	3570	420	372
*HXA30VI	170	1504.5	69.9	2300	2700	2390
*HXA40VI	228	2017.8	70.4	1610	3500	3098
*HXA40VG	230	2035.5	91.9	2180	3500	3098
*HXA40VE	230	2035.5	128.7	3100	3500	3098
*HXA50VF	280	2478.0	103.2	2070	4300	3806
*HXA50VE	280	2478.0	123.7	2450	4300	3806
*HXA60VF	320	2832.0	96.2	1660	5100	4514
*HXA60VD	315	2787.8	140.7	2550	5100	4514

* = Force air cooled motor

Servo Motors Brushless Servo Motors

This servo range offers an extremely wide choice of Brushless, Water-cooled Brushless Synchronous and DC Brush motors and compatible drives. In addition to standard products with torque ratings from 0.3 to 320 Nm, custom solutions allow us to meet standard and specialized servo applications across all industries.

OPTIONS

- Gearheads
- Power-off brakes
- Protection IP65
- Custom shafting and configurations
- Mating connectors and cable assemblies



CE

230 AND 460 VAC MODELS

ADJUSTABLE INTERCONNECTRON™ CONNECTORS

COMPACT SIZE WITH LOW ROTOR INERTIA

HIGH TORQUE AT ZERO SPEED

HIGH TORQUE TO INERTIA RATIO

4, 8 AND 10 POLE ZERO-COG DESIGNS

RESOLVER FEEDBACK STANDARD

IP64 PROTECTION STANDARD

SERVO DRIVES

Digivex Series

50 to 300A

Digivex is a family of high performance digital Brushless Servo drives available in continuous ratings from 2 to 300A. They are suitable for either speed control (DPD) or position/motion control (DPM).



SINGLE AXIS DRIVE WITH INTEGRATED 480 VAC POWER SUPPLY

REGENERATIVE BRAKING CIRCUITS OR REGENERATE INTO AC SUPPLY

REAL-TIME AND MULTI-TASKING STRUCTURE: 1 MOTION AND 2 PLC PROGRAMS

26 I/O INTERFACE

CANBUS INTERFACE

ENCODER OUTPUTS TO 16,384 LINES

DIGIVEX MOTION EXPLORER SOFTWARE

TWO PROCESSORS FOR 250 μSEC CYCLE TIMES

READY FOR CUT-TO-LENGTH, MASTER/SLAVE, POSITIONING, SYNCHRONIZATION, CAM PROFILING

DIGIVEX DPD/DPM SERIES SERVO DRIVES

DIGIVEX DPD/DPM SERIES SERVO DRIVES

Type	Amps Cont.	Amps Peak*	Cont. Output (kW)	Mech. Typ. (kW)	H (inch)	W (inch)	D*** (inch)	Weight (lbs)
DIGIVEX								
DPD17050	50	80	39.4	19.72	17.5	19	13.5	77
DPD17100	100	120	78.9	39.44				97
DPD17150	150	150	118.3	59.16	110			
DPD17200***	200	200	157.7	78.87	34.6	21.3		176
DPD17300***	300	300	236.6	118.31	34.6	21.3		220
DIGIVEX MOTION								
DPM17050	50	80	39.4	19.72	17.5	19	13.5	77
DPM17100	100	120	78.9	39.44				97
DPM17150	150	150	118.3	59.16	110			
DPM17200***	200	200	157.7	78.87	34.6	21.3		176
DPM17300***	300	300	236.6	118.31	34.6	21.3		220

* Peak amps for 5 seconds

** 2.75" must be allowed for connectors/cables.

*** Forced air Ventilation required.



PERMANENT MAGNET, COLD ROTOR

COMPACT SIZE WITH LOW ROTOR INERTIA

STABLE BALANCING

SPEED RANGE TO 50000 RPM

REDUCED MAINTENANCE

HIGH TORQUE AT ZERO SPEED

POSITIONING CAPABILITY

Servo Motors Synchronous Water Cooled Spindle Motors

The HW servomotors are water-cooled Brushless Synchronous motors delivered as individual components (rotor, stator and resolver) to make a complete spindle unit. These motors are driven by Digivex DPD or DPM series servo drives.

SERVO DRIVES

HW SPINDLE MOTORS - for use with 480 VAC Digivex Series Drives

Motor Type	Digivex Drive	Torque (S1/S3)	Torque (S1-S3)	Power (S1/S3)	Power (S1/S3)	Base Speed RPM	Max Speed RPM	Diameter
		Nm	lb-in	kW	HP			Inch
HW420BU	8/16	4.2	37.1	2.7	3.6	6130	50000	3.9
HW420BP	16/62	4.2	37.1	5.7	7.6	13000	50000	3.9
HW420BK	32/64	4.2	37.1	11.7	15.6	26600	50000	3.9
HW430BQ	16/32	6.7	59.3	5.5	7.3	7840	50000	3.9
HW430BL	32/64	6.7	59.3	11.5	15.4	16400	50000	3.9
HW430BI	50/80	6.7	59.3	18	24	25700	50000	3.9
HW620CN	16/32	8.3/10	73.5/88.5	4.8/5.8	6.4/7.7	5540	30000	5.1
HW620CI	32/64	8.3/10	73.5/88.5	10/12	13/16	11500	30000	5.1
HW635CI	32/64	15/18	132/159	10/12	13/16	6310	30000	5.1
HW635CF	50/80	15/18	132/159	15/18	20/24	9550	30000	5.1
HW820RR	32/64	21.5/26	190/230	8.3/10	11/13	3670	24000	7.1
HW820RP	50/80	21.5/26	190/230	13/16	17/21	5870	24000	7.1
HW820CR	32/64	25.8/31	228/274	10/12	13/16	3690	18000	7.1
HW820CP	50/80	25.8/31	228/274	15.6/19	20/25	5760	18000	7.1
HW840CR	32/64	57.3/66	507/584	10/11.5	13/15	1660	18000	7.1
HW840CP	50/80	57.3/66	507/584	15.7/18	21/24	2610	24000	7.1
HW840CH	100/120	57.3/66	507/584	33/38	44/50	5450	24000	7.1
HW840CF	150	57.3/70	507/619	42/51	56/68	7020	20000	7.1
HW930CJ	100/120	112	991	35	46	3020	20000	8.7
HW930CI	100/120	102	902	40	53	3700	20000	8.7
HW930CF	150	102	902	60	80	5620	20000	8.7
HW930CE	200	112	991	72	96	6180	20000	8.7
HW930CC	300	102	902	120	160	11200	20000	8.7
HW950CJ	100/120	186	1646	35	46	1800	20000	8.7
HW950CI	100/120	170	1504	39	52	2190	20000	8.7
HW950CF	150	170	1504	60	80	3370	20000	8.7
HW950CE	200	186	1646	73	97	3770	20000	8.7
HW950CC	300	170	1504	120	160	6850	20000	8.7
HWA30DN	50/80	260	2301	17	22	630	12000	10.6
HWA30DF	100/120	260	2301	37	49	1370	12000	10.6
HWA30DD	150	260	2301	58	77	2120	12000	10.6
HWA30DC	200	260	2301	78	104	2860	12000	10.6
HWA30DB	300	260	2301	117	156	4300	12000	10.6
HWA50DG	100/120	430/510	3805/4513	27/31	36/41	580	12000	10.6
HWA50DF	100/120	430	3805	36	48	800	12000	10.6
HWA50DD	150	430	3805	56	75	1250	12000	10.6
HWA50DC	200	430	3805	77	103	1720	12000	10.6
HWA50DB	300	430	3805	118	158	2610	12000	10.6
HWB20HH	150	575	5089	54	72	890	8000	13.3
HWB30HJ	150	940/1070	8319/9470	42/42	56/56	425	7000	13.3
HWB40HE	300	1250/1400	11063/12391	78/87	104/116	595	8000	13.3



Other Servo Motor Designs

AXEM - DISK ROTOR SERVOMOTORS FROM 0.14 TO 22.9 Nm

RX - THE ECONOMICAL DC BRUSH SOLUTION FROM 0.3 TO 8 Nm

RS - THE HIGH PERFORMANCE DC BRUSH RANGE FROM 0.05 TO 13 Nm

AXL - THE COMPACT MOTOR/REDUCER COMBINATION

XD - FOR USE IN HAZARDOUS ENVIRONMENTS

CUSTOMIZED MOTORS WITH SPECIAL CABLES, CONNECTORS, FEEDBACK, WINDINGS, FLANGES, ETC.

Reference Information

Abbreviations

Electrical Data

Kilowatts	=kW
Volts	=V
Armature Volts	=V _a
Field Volts	=V _f
Amperes	=A
Armature Current	=I _a
Field Current	=I _f
Power Factor	=PF

Servo

Useful Servo Drive Calculations

Correctly rating a servo motor and drive application often involves mechanical calculations. Below are typical examples of some of the commonly occurring formulae that are often encountered. These are provided for general guidance only and any results may need to be modified to take into account specific application details such as mechanical losses, inclined angles and duty cycles etc. Your local Eurotherm Drives sales office will always be pleased to assist in correctly sizing your application.

Time to accelerate a rotating mass

M(acc) = Acceleration Torque, Nm

J(tot) = Total Inertia, kgm²

J(mot) = Motor Inertia, kgm²

J(load) = Load Inertia, kgm²

R = Gearbox Ratio (Speed Reducing)

t(acc) = Acceleration time, sec

α = Angular Acceleration, rad.sec⁻²

ω = Angular Speed, rad.sec⁻¹

n = Angular Speed, rpm

$$M(\text{acc}) = J(\text{tot}) \times \alpha \text{ or } \alpha = M(\text{acc}) / J(\text{tot})$$

$$\alpha = \omega / t(\text{acc}) \text{ or } t(\text{acc}) = \omega / \alpha$$

$$\omega = (n/60) \times 2\pi$$

$$J(\text{tot}) = J(\text{mot}) + (J(\text{load})/R^2)$$

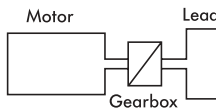

Example

$$J(\text{load}) = 0.50 \text{ kgm}^2$$

$$J(\text{mot}) = 5.0 \text{ kgcm}^2 (=0.00050 \text{ kgm}^2)$$

$$R = 30:1$$

$$n = 1500 \text{ rpm}$$

$$M(\text{acc}) = 15 \text{ Nm}$$

$$J(\text{tot}) = 0.00050 + (0.5 / 30^2)$$

$$J(\text{tot}) = 0.00106 \text{ kgm}^2$$

$$\alpha = 15 / 0.00106$$

$$\alpha = 14,150 \text{ rad.sec}^{-2}$$

$$\omega = (1500/60) \times 2\pi$$

$$\omega = 157 \text{ rad.sec}^{-1}$$

$$t(\text{acc}) = 157 / 14,150$$

$$t(\text{acc}) = 0.0111 \text{ sec (11.1mS)}$$

Useful Conversion Factors

$$1 \text{ HP} = 746 \text{ W}$$

$$1 \text{ Nm} = 8.851 \text{ lb.in}$$

$$1 \text{ mm} = 0.3937 \text{ inch}$$

$$1 \text{ m}^2 = 35.31 \text{ ft}^2$$

$$1 \text{ kg.m}^2 = 1 \text{ Nms}^2 = 0.73756 \text{ lb.ft.S}^2$$

Useful formula

$$1 \text{ Watt} = 1 \text{ Nm/s}$$

$$\text{Torque (lb ft)} = \frac{5250 \times \text{HP}}{\text{speed (rpm)}}$$

$$\text{Torque (Nm)} = \frac{9549 \times \text{kW}}{\text{speed (rpm)}}$$

$$3 \text{ phase ac power (kW)} = \frac{1.732 \times V \times I \times \text{PF}}{1000}$$

$$1 \text{ phase ac power (kW)} = \frac{V \times I \times \text{PF}}{1000}$$

Useful Inertia Formula

Servo drives are often employed in highly dynamic applications where rapid and accurate positioning is required. To obtain the ultimate performance in any system, the reflected load inertia (taking into account any gearbox or pulley ratios) should equal the motor inertia. This is often not possible, but ratio mismatches of typically 5:1 are not normally significant. The greater the mismatch between reflected load inertia and motor inertia, the lower will be the dynamic performance of the system.

Solid Cylinder Rotating About Axis XX

$$J = (mR^2)/2$$

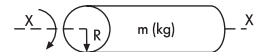

Hollow Cylinder Rotating About Axis XX

$$J = m(R^2 + r^2)/2$$

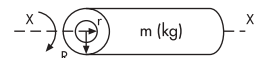

Equivalent Inertia of Slide Mass on a Ballscrew

$$J = m(s/2\pi)^2$$



Effect of Gear Ratio on Reflected Inertia

$$J = J(\text{load}) / R^2$$

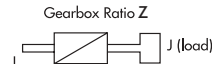

Torque Required to Produce a Force on a Leadscrew

M = Required Torque, Nm

F = Linear Force, N

R = Gearbox Ratio (Speed Reducing)

(R = 1 for direct drive)

s = Ballscrew Pitch, m

η = Efficiency

$$M = Fs / 2\pi R \eta$$

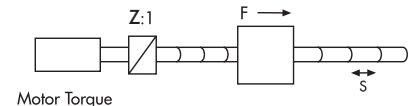

Example

$$F = 10,000 \text{ N}$$

$$s = 10 \text{ mm (0.01 m)}$$

$$R = 2:1$$

$$\eta = 0.9$$

$$\text{Required motor torque } M = (10,000 \times 0.01) / (2\pi \times 2 \times 0.9) = 8.85 \text{ Nm}$$

(nb; The required force is often provided in kg's or kgf. This implies the force exerted on the mass by gravity (g) and must be multiplied by 9.81 to obtain the force in N (newtons); eg A "force" of 100kg is 981N)

EUROTHERM DRIVES WORLDWIDE Overseas Companies

AUSTRALIA
Eurotherm Pty Limited
Unit 10,
40 Brookhollow Avenue,
Baulkham Hills,
New South Wales 2153,
Australia.
Tel: +61 (2) 9634 8444
Fax: +61 (2) 9634 8555

AUSTRIA
Eurotherm GmbH
Geiereckstrasse 18/1,
A1110 Vienna,
Austria.
Tel: +43 (1) 798 7601
Fax: +43 (1) 798 7605

BELGIUM
Eurotherm B.V.
Rue du Val-Notre Dame 384,
B-4520 Moha (Vinalmont),
Tel: +32 85 274080
Fax: +32 85 274081

CANADA
Eurotherm Drives Inc.
880 Laurentian Drive,
Burlington,
Ontario, L7N 3V6,
Canada.
Tel: +1 (905) 333 7787
Fax: +1 (905) 632 0107

DENMARK
Eurotherm Drives Denmark
Enghavevej 11,
DK-7100,
Vejle
Denmark.
Tel: +45 (70) 201311
Fax: +45 (70) 201312

FINLAND
Eurotherm Drives Finland
Storgatan 13, 2-VAN
Fin-686 00
Jakobstad
Tel: +358 (0)67 231040
Fax: +358 (0)67 231043

HONG KONG
Eurotherm Ltd
Unit D,
18/F Gee Chang Hong Centre,
65 Wong Chuk Hang Road,
Aberdeen,
Hong Kong.
Tel: +852 2873 3826
Fax: +852 2870 0148

INDIA
Eurotherm India Limited
152 Developed Plots Estate,
Perungudi,
Chennai 600 096
India.
Tel: +91 (44) 496 1129
Fax: +91 (44) 496 1831

IRELAND
Eurotherm Ireland Ltd
I.D.A. Industrial Estate,
Monread Road,
Naas,
Co. Kildare,
Republic of Ireland.
Tel: +353 (45) 879937
Fax: +353 (45) 875123

JAPAN
Densei-Lambda K K
Eurotherm Division, Aroma
Square,
5F, PO Box 40, 5-37-1, Kamata,
Ota-Ku, Tokyo 144-8721
Tel: +81 (03) 5714 0620
Fax: +81 (03) 5714 0621

KOREA
Eurotherm Korea Ltd
3F J-Building,
402-3 Poongnab-Dong,
Songpa-Ku,
Seoul 138-040,
Korea.
Tel: +82 (2) 478 8507
Fax: +82 (2) 488 8508

NETHERLANDS
Eurotherm B.V.
Genielaan 4,
2404CH,
Alpen aan den Rijn,
Netherlands.
Tel: +31 (172) 411 752
Fax: +31 (172) 417 260

NORWAY
Eurotherm Drives
Norge
Postboks 650,
1411 Kolbotn,
Oslo, Norway.
Tel: +47 (66) 803330
Fax: +47 (66) 803131

SPAIN
Eurotherm Espana SA
Calle La Granja 74,
Pol. Ind. Alcobendas,
28108,
Madrid,
Spain.
Tel: +34 (91) 6616001
Fax: +34 (91) 6619093

SWITZERLAND
Eurotherm Produkte
(Schweiz) AG
Schwerzistrasse 20
CH-8807 Freienbach,
Switzerland.
Tel: +41 (55) 4154400
Fax: +41 (55) 4154415



EUROTHERM DRIVES

General Commercial Information

Note that we have a \$100 minimum order charge. Please confirm price and delivery against your specific requirements when placing your order. All information presented in this catalog is given without commitment as a general indication of our product range.

Every effort has been taken to ensure the accuracy of this catalog. However, we are continuously improving our products which could, without notice, result in amendments to specifications, or omissions to this catalog. We cannot accept responsibility for consequential damage, injury, loss or expenses resulting therefrom.

If you send us a written order containing your standard purchasing conditions, we will assume you are prepared to accept our terms of trading unless you send a covering letter stating to the contrary. If you wish to confirm in writing an order placed verbally or by fax, please assist us in avoiding duplication by clearly marking it 'confirmation only'.

Cancellation of orders or return of goods may only be made with the consent of Eurotherm Drives. Any credit agreed may be subject to a handling, retest and repackaging charge. Custom made goods may be excluded from return.

These general terms of business are for guidance only and are applicable within the USA. All goods, services and software offered are subject to our Terms and Conditions of Sale, copies of which are available upon request.

Compliance Information

The products offered in this catalog are classed as professional equipment for restricted sales applications to end users of permanently connected industrial motor control applications. As such, these products have been assessed in accordance with industrial electrical/mechanical safety and EMC standards, and must be installed and maintained by qualified personnel in accordance with local regulations. A qualified person is someone who is technically competent and familiar with all electrical/mechanical safety and EMC information and established practices. Refer to individual product manuals for information concerning compliance and other legal responsibilities.

Local availability and service support also in:

ARGENTINA – BRAZIL – CHILE – COLOMBIA – CYPRUS – CZECH REPUBLIC
DENMARK – EGYPT – HUNGARY – ICELAND – INDONESIA – IRAN
ISRAEL – KENYA – KOREA – LITHUANIA – MALAYSIA – MOROCCO
NEW ZEALAND – NORWAY – PHILIPPINES – POLAND – PORTUGAL
ROMANIA – SINGAPORE – SOUTH AFRICA – TAIWAN
THAILAND – TURKEY – UNITED ARAB EMIRATES

UNITED STATES

Eurotherm Drives, Inc.

9225 Forsyth Park Drive, Charlotte, North Carolina 28273-3884
Tel: 704-588-3246 Fax: 704-588-3249

ENGLAND

Eurotherm Drives Ltd.

New Courtwick Lane, Littlehampton, West Sussex. BN17 7PD
Tel: 011-44-1-903-737000 Fax: 011-44-1-903-732444

FRANCE (DRIVES)

Eurotherm Vitesse Variable SA

27 Avenue du Québec, Z.A. de Courtaboeuf, 91951 Les Ulis Cedex
Tel: 011-331-6918-5151 Fax: 011-331-6918-5059

FRANCE (SERVO)

Eurotherm Parvex

8 Avenue du Lac, B.P. 249, F-21007 Dijon Cedex
Tel: 011-333-8042-4140 Fax: 011-333-8042-4123

GERMANY

Eurotherm Antriebstechnik GmbH

Von-Humboldt - Strasse 10, 64646 Heppenheim
Tel: 011-49-6252-7982-00 Fax: 011-49-6252-7982-05

ITALY

Eurotherm Drives SpA

Via Gran Sasso 9, 20030 Lentate Sul Seveso, Milano
Tel: 011-39-362-557308 Fax: 011-39-362-557312

SWEDEN

Eurotherm Drivteknik AB

Box 9084, S30013 Halmstad
Tel: 011-46-35-177300 Fax: 011-46-35-108407

www.eurothermdrives.com

E-mail: info@eurothermdrives.com

AC DRIVES

DC DRIVES

MOTORS

LINK

SERVO DRIVES

